

# DEXIBELL

# VIVO | SX8 |

digital piano module

## Owner's Manual



HANDMADE  
**IN ITALY**

## Regulatory and Safety Information

### Users in U.S.A

This product has been tested and found to comply with the limits for a Class B digital device, pursuant to Part 15 of the FCC Rules. These limits are designed to provide reasonable protection against harmful interference in a residential installation. This equipment generates, uses, and can radiate radio frequency energy and, if not installed and used in accordance with the instructions, may cause harmful interference to radio communications. However, there is no guarantee that interference will not occur in a particular installation. If this equipment does cause harmful interference to radio or television reception, which can be determined by turning the equipment off and on, the user is encouraged to try to correct the interference by one or more of the following measures:

- Reorient or relocate the receiving antenna.
- Increase the separation between the equipment and receiver.
- Connect the equipment into an outlet on a circuit different from that to which the receiver is connected.
- Consult the dealer or an experienced radio/TV technician for help.

This device complies with part 15 of the FCC Rules. Operation is subject to the following two conditions:

- 1) This device may not cause harmful interference; and
- 2) This device must accept any interference received, including interference that may cause undesired operation.

**FCC CAUTION:** Any unauthorized changes or modifications not expressly approved by the party responsible for compliance could void the user's authority to operate the equipment.

**NOTE:** The manufacturer is not responsible for any radio or tv interference caused by unauthorized modifications to this equipment. Such modifications could void the user's authority to operate the equipment.

### Radiation Exposure Statement

This product complies with the US portable RF exposure limit set forth for an uncontrolled environment and is safe for intended operation as described in this manual. Further RF exposure reduction can be achieved if the product is kept as far as possible from the user body or is set to a lower output power if such function is available.

This transmitter must not be co-located or operated in conjunction with any other antenna or transmitter.

### Users in Canada

This device complies with Industry Canada's licence-exempt RSSs. Operation is subject to the following two conditions:

- (1) this device may not cause interference, and
- (2) this device must accept any interference, including interference that may cause undesired operation of the device.

Le présent appareil est conforme aux CNR d'Industrie Canada applicables aux appareils radio exempts de licence. L'exploitation est autorisée aux deux conditions suivantes: (1) l'appareil ne doit pas produire de brouillage, et (2) l'utilisateur de l'appareil doit accepter tout brouillage radioélectrique subi, même si le brouillage est susceptible d'en compromettre le fonctionnement.

### Radiation Exposure Statement

The product complies with the Canada portable RF exposure limit set forth for an uncontrolled environment and are safe for intended operation as described in this manual. The minimum separation distance for portable use is limited to 15mm assuming use of antenna with 2 dBi of gain. The further RF exposure reduction can be achieved if the product can be kept as far as possible from the user body or set the device to lower output power if such function is available.

Le produit est conforme aux limites d'exposition pour les appareils portables RF pour les Etats-Unis et le Canada établies pour un environnement non contrôlé. La distance de séparation minimale pour l'utilisation portative est limitée à 15mm en supposant l'utilisation de l'antenne avec 2 dBi de gain. Le produit est sûr pour un fonctionnement tel que décrit dans ce manuel. La réduction aux expositions RF peut être augmentée si l'appareil peut être conservé aussi loin que possible du corps de l'utilisateur ou que le dispositif est réglé sur la puissance de sortie la plus faible si une telle fonction est disponible.

### Users in EU

This device complies with Industry Canada's licence-exempt RSSs. Operation is subject to the following two conditions:

This device complies with the essential requirements of the 2014/53/EU – Radio Equipment Directive (RED). The following test methods have been applied in order to prove presumption of conformity with the essential requirements of the 2014/53/EU – Radio Equipment Directive (RED):

- EN 62368-1:2014/A11:2017  
Safety requirements for audio/video, information, and technology equipment
- EN 300 328 v2.2.2 (2019-07)  
Wideband transmission systems; Data transmission equipment operating in the 2,4 GHz band; Harmonized Standard for access to radio spectrum
- EN 62311:2008 | EN 50385:2017  
RF exposure
- EN 301 489-1 v2.2.0 (2017-03)  
Electromagnetic compatibility and Radio Spectrum Matters (ERM); ElectroMagnetic Compatibility (EMC) standard for radio equipment and services; Part 1: Common technical requirements
- EN 301 489-17 V3.2.0 (2017-03)  
Electromagnetic compatibility and Radio spectrum Matters (ERM); ElectroMagnetic Compatibility (EMC) standard for radio equipment and services; Part 17: Specific conditions for 2,4 GHz wideband transmission systems and 5 GHz high performance RLAN equipment
- EN 301 893 v2.1.1 (2017-05)  
5 GHz RLAN; Harmonized Standard covering the essential requirements of article 3.2 of Directive 2014/53/EU
- EU 2015/863 (RoHS 3)  
Declaration of Compliance – EU Directive 2015/863; Reduction of Hazardous Substances (RoHS)

# VIVO | SX8 |

digital piano module

## Owner's Manual

Welcome to the reference manual of VIVO SX8 and congratulations to purchasing this Sound Module.

VIVO SX8 is the Sound Module of Dexibell's new VIVO PREMIUM digital piano series.

A realism never heard before, thanks to the latest technology managed of a most powerful processor equipped with 3.2 GB size of memory for sounds.

All sounds was recorded with **holophonic** method for an amazing 3D listening experience and reproduced using the new technology called **T2L (True to Life)**, based on interaction between Sampling and Modelling methods. Moreover, the sound quality has been raised-up to **24 bit - 48KHz** with an average of 5 times longer ever recorded samples (15" on lower piano notes).

VIVO SX8 reproduces a real acoustic piano also thanks to unlimited notes polyphony (320 oscillators).

The real sustain pedal simulation is designed for good-feeling response, and allows subtle performance nuances to be expressed.

Moreover, an organ section with many effects as rotary, percussion, vibrato, chorus, allows you to enjoy full-fledged organ sounds in your performances.

Reading this manual you will discover many other features such as sympathetic resonances, harmonics, noises, staccato sounds, timbre variances, etc, etc.

To ensure that you obtain the maximum enjoyment and take full advantage of the piano functionality, please read all sections of this owner's manual carefully.

Keep this manual handy for future reference.



Start to take advantage of valuable benefits available simply registering your product on [www.dexibell.com](http://www.dexibell.com).

- You can benefit of DEXIBELL's **3 years** extended warranty (*The extended warranty is subject to terms and conditions. Please refer to the related section*).
- Keeps you updated on special offers.
- You can be updated on any new software release and new sounds.

# 1 Important Safety Instruction

## PLEASE READ CAREFULLY BEFORE PROCEEDING

Always follow the following precaution listed below to avoid user to the risk of serious injury or even death from electrical shock, fire or other hazard .



### WARNING



### CAUTION

#### Only use non-tropical weather

This unit and its AC adaptor can only be safely used in non-tropical weather. The operating temperature range is 5° - 40°C (41° - 104°F).



#### Do not repair, modify or replace parts by yourself

Do not attempt to repair the unit, modify or replace parts of the product. Please contact all the nearest Dexibell Service Center.



#### Do not disassemble or modify by yourself

Do not open the unit or its AC adaptor or attempt to disassemble or modify the internal component in any way.



#### Use only the supplied AC adaptor (DEXIBELL DYS624-120200W).

Use only the AC adaptor included with the unit. Connecting a different AC adaptor can cause serious damage to the internal circuitry and may even pose a shock hazard.



#### Use only the supplied power cord

Use only the AC power cord supplied with the AC adaptor included in the package.



#### Do not excessively bend the power cord

Do not excessively twist or bend the power cord otherwise you damage it. Damaged cords may cause fire and shock hazards!



#### Do not place the unit in an unstable location

Do not place the unit in a unstable position where it might accidentally fall over.



#### Take care not to allow liquid or foreign objects to enter unit; Do not place containers with liquid on unit

Do not place object filled with liquid (glass of water on this product. Never allow foreign objects (e.g. flammable objects, coins, wires) or liquids (e.g., water or juice) to enter this product. Doing so may cause short circuits, faulty operation, or other malfunctions.



#### Never place or store the product in the following types of locations

- Exposed to extreme cold or heat (such as in direct sunlight, near a heater, or in a car during the day).
- Subject to steam or smoke.
- Damp (such washroom, baths, on wet floors).
- Subject to salt water exposure.
- Exposed to rain.
- Dusty or sandy.
- Subject to extreme changes of temperature or humidity (The condensation may occur and water may collect on the surface of the instrument. Wooden parts may absorb water and be damaged).
- Subject to high levels of vibration and shakiness.



#### Do not drop the unit or subject it to strong impact

Do not drop the unit. Protect it from strong impact!



#### Do not connect the unit to an outlet with an unreasonable number of other devices

Do not connect the unit's power-supply cord to an electrical outlet with an unreasonable number of other devices. This could cause the outlet to overheat and possibly cause a fire.



#### Adults must provide supervision in places where children are present

When using the unit in locations where children are present, never leave the unit unattended. Keep a special watch over any children so that they don't mishandling of the unit can take place.



#### Avoid extended use at high volume

This unit, either alone or in combination with an amplifier and headphones or speakers, may be capable of producing sound levels that could cause permanent hearing loss. DO NOT operate for a long period of time at a high volume level, or at a level that is uncomfortable. If you experience any hearing loss or ringing in the ears, you should immediately stop using the unit, and consult an audiologist.



#### If you notice any abnormality turn off the unit immediately

- Turn off the unit and remove the AC adaptor from the outlet when:
- If the AC adaptor, the power-supply cord, or the plug has been damaged.
  - If smoke or unusual smells occurs.
  - If the product has been exposed to rain.
  - If objects have fallen into, or liquid has been spilled into the unit.
  - If the unit does not operate or exhibits a marked change in performance.
  - If the unit has been dropped, or the enclosure of the product has been damaged.



Contact the nearest qualified Service Center.

#### Grasp the plug connecting or disconnecting the AC adaptor

When removing the electric plug from the instrument or an outlet, always hold the plug itself and not the cord. Pulling by the cord can damage it.



#### Do not use wet hands to connect or disconnect AC adaptor

Never handle the AC adaptor or its plugs with wet hands when plugging into, or unplugging from, an electrical outlet.



#### Keep clean the AC adaptor's plug

At regular intervals, unplug the AC adaptor and using a dry cloth clean the adaptor's plug.



If the unit will be unused for an extended period of time, unplug the AC power cord from the AC outlet.

#### Keep cables from getting entangled

Try to prevent cords and cables from becoming entangled. Place all cords and cables away from children.



#### Before cleaning the unit, unplug the AC adaptor from the outlet

To avoid electric shock or damage the unit, before cleaning the unit, turn it off and unplug the AC adaptor from the outlet (p. 12).



#### If there is a possibility of lightning strike in your area, disconnect the AC adaptor from the outlet

If you know a thunderstorm is predicted in your area, disconnect the AC adaptor from the outlet.



#### Do not rest your weight on or place heavy objects on the unit.

Avoid to climb on top of, nor place heavy objects on the unit.



#### Place in a well ventilated location

The unit and the AC adaptor should be located so their location or position does not interfere with their proper ventilation.



#### Do not use in tropical climates

Use the unit and the AC adaptor only in a moderate climates (not in tropical climates).



#### Place near the socket outlet

This equipment should be installed near the socket outlet and disconnection of the device should be easily accessible.



This Symbol indicates that in EU countries, this product must be collected separately from household waste, as defined in each region. Products bearing this Symbol must not be discarded together with household waste.

For European Countries

# 2 Relevant Indications

In addition to the items listed under "Important Safety Instruction" on p. 4, please read and observe the following:



## Power supply related

- Do not plug this unit into the same electrical outlet used same by an electrical appliance that is controlled by an inverter or a motor (such as a refrigerator, washing machine or air conditioner). Doing so, can result an audible noise.
- The power adaptor may become warm after long hours of consecutive use. It can be a normal dissipation of heat through the adaptor casing. To reduce the possibility of overheating place the power adaptor on the floor in a well-ventilated location.
- Before connecting the unit to other equipment, turn off the power to all equipment. Otherwise, electrical shock or damage to the equipment may occur.
- If the unit is not operative for 120 minutes. to prevent unnecessary power consumption, this unit features an "AUTO OFF" function that automatically turns the unit off. If you don't want the unit to turn off automatically, change the "AUTO OFF" setting to "OFF" as described on "Auto OFF" (p. 57).

### NOTE

The "AUTO OFF" setting is memorized when you switch off the unit.



## Maintenance related

- To clean the unit, put a soft cloth in lukewarm water, squeeze it well, then wipe the entire surface using an equal amount of strength. Rubbing too hard in the same area can damage the finish.
- Do not wipe this unit with benzene, alcohol or solvent of any kind. Doing so may result in discoloration and/or deformation of the unit.



## Related to repairs

- Always back up your data on a USB memories before you send this unit for repair to an authorized center. All data contained in the unit's memory may be lost. Important data should always be backed up, or written down on paper (when possible). Dexibell assumes no liability concerning such loss of data.



## Related to appropriate location

- Do not place the unit near power amplifiers (or other equipment containing large power transformers) to avoid induced hum. In case of hum, to reduce the problem, change the orientation of your unit or place it away from the source of interference.
- Do not use this unit in the vicinity of a TV or radio. This unit may interfere with radio and television reception.
- When using this unit along with application on your iPhone/iPad, we recommend that you set "Airplane Mode" to "ON" on your iPhone/iPad in order to avoid noise caused by communication.
- Noise may be produced if cell phones are operated in the vicinity of this unit. In case of noise you should relocate such wireless devices so they are at a greater distance from this unit, or switch them off.
- Do not expose the unit to extreme cold or heat, to direct sunlight or near devices that radiate heat. Do not leave the unit inside a vehicle during the day. Extreme temperature can damage the unit.
- Take care when move the unit from one location to another with drastic changes in ambient temperature. Condensation can occur in the unit due to drastic change of temperature. Using the device while condensation is present can cause damage. If there is reason to believe that condensation might have occurred, leave the device for several hours until the condensation has completely dried out.
- Do not place, for long periods of time, vinyl, plastic or rubber objects on this unit. Such objects can discolor or otherwise harmfully affect the finish.
- Do not place objects for long period of time on top of the keyboard. This can be the cause of malfunction of the keys of the keyboard.
- Do not apply any stickers, decals or self-adhesive material to this unit. The glue is difficult to remove and solvents are damaging the exterior finish.
- Do not place object filled with liquid (glass of water on this unit. Avoid to use alcohol, perfume, hairspray, nail polish, etc., near the unit. In the event of liquid spill on the unit, swiftly wipe away the surface using a dry, soft cloth.



## Related to external memories

- Insert the USB Memory (commercially available) into the slot with care and at the correct angle.
- Take particular care when handling USB Memory:
  - Always ground yourself to something metal before handling an USB Memory.
  - Do not touch the pins of the USB Memory connector, or allow them to become dirty.
  - Do not subject the USB Memory to temperature extremes (e.g., direct sunlight in an enclosed vehicle).
  - Do not allow the USB Memory to become wet.
  - Do not drop or subject it to excessive shock or vibration.
- Do not disconnect the USB Memory while writing and reading data (i.e., while the USB Memory indicator blinks).
- This unit allows you to use commercially available USB Memory. You can purchase such devices at a computer store, a digital camera dealer, etc.



### Other precautions

- The contents of memory could be lost due to malfunction or improper operation. To help prevent the loss of your data, we highly recommend that you periodically save a backup copy of important data you have stored in the unit's memory on another storage device. (e.g., USB memories).
- Unfortunately, an error may occur during the data restore previously stored in the USB memories. Dexibell shall not be liable for loss of profits or any consequential loss, loss of data.
- Do not use excessive force when handling unit's buttons, switches, sliders and controls and when use connectors and jacks. Rough handling can cause damage o malfunctions.
- Do not to apply strong pressure on the display.
- Always pull by the connector when disconnecting a cable, never pull the cable Not doing so you will cause shorts, or damage to the cable's internal elements.
- Keep the unit's volume levels down. The instrument should be used at a reasonable volume, to avoid disturbing neighbours, especially at night and in the early morning. Use headphones if you want to play your music loud or late at night.
- When you need to transport the unit, put it in its original packaging with padding in the box. Otherwise, you will need to use equivalent packaging materials. When transporting or moving the unit always use two or more people.
- For connecting this unit use cable low impedance cables. The use of cables that contain resistor can cause the sound level to be extremely low, or impossible to hear.



### Related to copyright and trademarks

- Dexibell do not assume legal liability regarding any infringements of the user through the use of this unit.
- Recording, copying, distribution of copyrighted material (songs, live performance, etc.) belonging to a third party in part or in whole without the permission of the copyright owner is forbidden by law.
- Copyright © 2003 by Bitstream, Inc. All rights reserved. Bitstream Vera is a trademark of Bitstream, Inc.
- iPad® and iPhone® are registered trademarks of Apple Inc.
- App Store<sup>sm</sup> is an Apple's Service Mark.
- Bluetooth® is registered trademarks of Bluetooth SIG, Inc.

### Conventions Used in This Manual

The following symbols are used.

- |             |  |
|-------------|--|
| <b>NOTE</b> | It indicates an important note; be sure to read it.                            |
| <b>MEMO</b> | It indicates a memo regarding the setting or function; It's up to you read it. |
| <b>TIPS</b> | It indicates a useful hint for operation; read it as necessary.                |

# Contents

Restore Your Settings, Contents and Sounds List .....	31
Panic Function .....	31
<b>Additional Sound (Sound Library) .....</b>	<b>32</b>
Remove and Add Sound Libraries .....	32
Removing a Sound Library .....	33
How To Load Sound Libraries From a USB Memory .....	33
Adding a Library .....	33
How to Select USER Sounds .....	35
How to Select USER Organ Sounds .....	35
How to Select USER Orchestral Sounds .....	35
<b>Sound Setup (Export/Import) .....</b>	<b>36</b>
Exporting a Sound Set ("EXPORT SETUP") .....	36
Importing a Sound Set ("IMPORT SETUP") .....	36
<b>Personalizing Your Sounds .....</b>	<b>37</b>
Making Slight Additions or Sound Alterations .....	37
Parameters to be edited .....	37
Orchestral Sounds Parameters .....	37
Organ Sounds Parameters .....	39
Adjusting the Keyboard Velocity Response According to the Sound .....	41
<b>Working with the Memories .....</b>	<b>42</b>
About the Memories and Memory Set structure .....	42
Saving Your Settings in the Internal Memory .....	42
Recalling your Settings from Internal Memory .....	42
How to Rearrange the Order of Memories .....	42
Saving Your Settings in the USB Memory (commercially available) .....	43
Recalling your settings from an USB Memory .....	44
Renaming a Memory .....	44
Exporting a Memory Set in the USB Memory .....	45
Importing a Memory Set from the USB Memory .....	45
Deleting a Memory Set .....	46
How to Automatically Recall Your Favorite Setting at the Power On .....	46
<b>Playing with Audio Backing Tracks .....</b>	<b>47</b>
Connecting your Mobile Device .....	47
Playing with X MURE Application .....	47
<b>Wireless Function .....</b>	<b>48</b>
Bluetooth® Audio and MIDI Connectivity .....	48
Turning on the VIVO SX8's Bluetooth® Functions .....	48
Connecting with the Mobile Device .....	48
Connecting an Already Paired Mobile Device .....	49
Using Bluetooth® Audio .....	49
Transferring Bluetooth® MIDI Data .....	49
<b>MENU Options (Advanced Section) .....</b>	<b>51</b>
General procedure .....	51
SOUND LIBRARY Functions .....	52
SOUND SETUP Functions .....	52
SOUND LIST .....	52
SETTING Parameters Group .....	52
T2L EDITOR .....	52
EFFECTS .....	52
OUTPUT .....	53
CONTROL .....	53
TUNING .....	54
MEMORY .....	55
USB MEMORY .....	55
USB AUDIO .....	55
BLUETOOTH .....	55
MIDI .....	56
GLOBAL .....	57
FACTORY RESET .....	57
FACTORY SOUND .....	57
BACKUP .....	57
PANIC .....	57
VERSION INFO .....	57
<b>Appendix .....</b>	<b>58</b>
Effects Types and Parameters List .....	58
VIVO SX8's Tone List .....	61
VIVO SX8's Organ Preset List .....	62
Drawbars MIDI Controls .....	63
<b>Troubleshooting .....</b>	<b>64</b>
<b>Specifications .....</b>	<b>65</b>
<b>Index .....</b>	<b>66</b>
<b>Important Safety Instruction .....</b>	<b>4</b>
<b>Relevant Indications .....</b>	<b>5</b>
<b>Panel Description .....</b>	<b>8</b>
Rear Side .....	9
<b>Examples of Connections .....</b>	<b>10</b>
<b>Quick Guide Basic Operations .....</b>	<b>11</b>
<b>Before You Start to Play .....</b>	<b>12</b>
Connecting the AC Adaptor .....	12
Secure the AC Adaptor .....	12
Connecting External Audio Amplifier .....	12
About the Pedals .....	12
Listening Through Headphones .....	13
Connecting an USB Memory (commercially available) .....	13
How to Format the USB Memory .....	13
Safely Remove the USB Memory .....	14
Ground Terminal .....	14
Turning the Power On/Off .....	14
Turning the Power Off .....	14
Demo of the VIVO SX8 .....	15
<b>Basic Operation .....</b>	<b>16</b>
About the Display and Cursor Operation .....	16
Main Page .....	16
Moving the cursor and setting parameter values .....	17
Assigning the Name You Specify .....	17
<b>Main Connections .....</b>	<b>18</b>
Connect a MIDI Keyboard .....	18
Connect a USB MIDI Keyboard .....	18
Matching MIDI Channels .....	18
Using the VIVO SX8 with Your Computer .....	19
USB Audio Feature .....	19
Adjusting the USB Audio .....	19
<b>Selecting the Tones .....</b>	<b>20</b>
How to Select a Part .....	20
How to Select Tones .....	20
How to Select Tones From the Main Page .....	20
Selecting Tones from a Tone List by the [SOUND] Button .....	20
How to Reorder the Tone List .....	20
Tone MIDI Information .....	21
<b>Organ Section .....</b>	<b>22</b>
Selecting Presetted Organ Sounds .....	22
Selecting Various Organ Types .....	22
How to Set Up Your Footage Configuration Starting From an Organ Preset .....	23
Adding Harmonic Percussion .....	23
Applying Vibrato/Chorus Effect .....	24
Adding Overdrive Effect .....	24
Organ Common Parameters .....	24
Adding Rotary Effect .....	25
<b>Parts &amp; MIDI Settings .....</b>	<b>26</b>
Part Settings .....	26
Transposing the Pitch of the Parts .....	26
MIDI Settings .....	26
MIDI Reception .....	26
MIDI Transmission .....	27
Specifying the Audio Output for Each Part .....	28
<b>Adding Effects to Orchestral Sound .....</b>	<b>29</b>
Going Around Sound Effects .....	29
Adding Reverb to the Sound .....	29
<b>Other Functions .....</b>	<b>30</b>
Master Equalizer .....	30
Master Equalizer Preset .....	30
Saving Your User Preset .....	30
Restoring the Factory Settings (Factory Reset) .....	30
Restore the Factory Sounds .....	30
How to Protect Your Settings, Contents and Sounds List (Backup) .....	31
Backup Your Settings, Contents and Sounds List .....	31

# 3 Panel Description

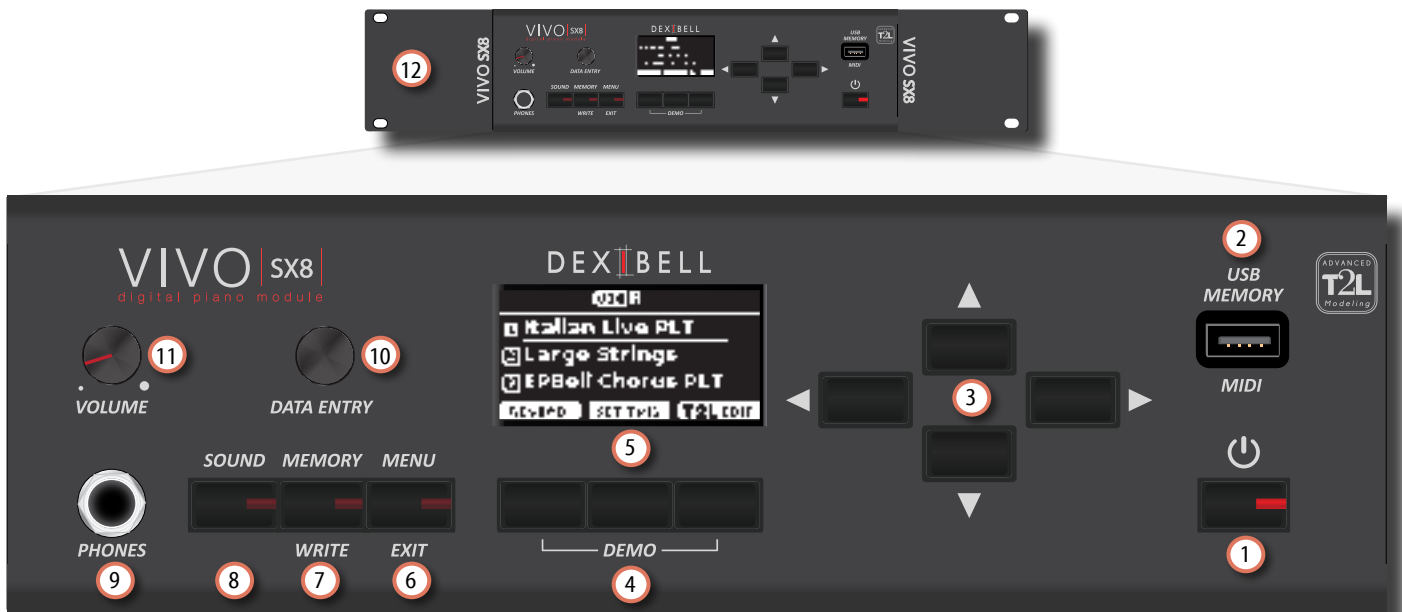

1

Turns the power on or off (p. 14).

**With the factory settings VIVO SX8's power will automatically be switched off 120 minutes after you stop playing or operating the VIVO SX8.**

If VIVO SX8's power has been turned off automatically, you can use the [POWER] switch to turn the VIVO SX8 back on. If you don't want the power to turn off automatically, set the "AUTO OFF" parameter to "OFF" (p. 57).

**NOTE**

To avoid malfunctions, never disconnect the AC/DC adaptor while the instrument is turned on.

2 **USB Memory Port**

- You can connect a commercially available USB Memory to save or load Memories, Sound Set and other data (p. 13).
- Using an A→B-type cable, you can connect keyboards from any brand directly to this port to exchange MIDI data without a computer and without using two MIDI cables (p. "Main Connections" (p. 18).

**NOTE**

- \* Carefully insert the USB Memory or a USB cable making sure that the connector on the device is appropriate and that it is connected in the proper direction.
- \* Dexibell does not recommend using USB hubs, irrespective of whether they are active or passive.

3 **Arrow buttons**

These buttons are used to navigate around the various menus and adjust values.

4 **Function buttons**

These buttons are used to select one of three functions/options shows at the bottom of the display. Press the first and the last Function button to listen the demo song.

5 This display shows information related to your operation.

The last row of the display shows the functions that you can recall pressing one of three buttons below the display.

6 **MENU/EXIT**

This button allows you to open and close the menu page where you can view and select all available functions.

7 **MEMORY/WRITE button**

This button allows you to shows the list of memories and then recall one of them. (See p. 42).

Pressing and holding this button to write a memory (See p. 42).

8 **SOUND**

By this button you can change the sound of the currently selected part. The tone list is displayed. See "Selecting the Tones" (p. 20).

9 **PHONES output**

This is where you can connect a pair of optional headphones.

10 **DATA ENTRY**

Use it to edit values or scroll through a list.

11 **VOLUME**

Use this knob to set VIVO SX8's overall volume.

12 **Rack-mount bracket**

Use these when installing the VIVO SX8 in a 19-inch rack.

For details on how to install the VIVO SX8 in a rack, refer to the owner's manual included with the rack you're using.



## Rear Side

**13 DC IN socket**

Connect the supplied AC/DC adaptor here (p. 12).

**14 Ground terminal**

Depending on the circumstances of a particular setup, you could feel a tingling sensation at the point where you touch this device.

You can eliminate this sensation connecting the ground terminal with an external ground. For details see "Ground Terminal" (p. 14).

**15 Cable clamp**

Use this to secure the AC adaptor cord (p. 12).

**16 UNBALANCED MAIN/SUB OUTPUT R, L/MONO sockets**

These TS sockets allow you to connect powered speakers or amp (p. 10). All parts of the instrument can be routed to the different outputs (MAIN or SUB) as desired. You can set this output as MAIN (default) or SUB. For details see "Specifying the Audio Output for Each Part" (p. 28).

**17 BALANCED OUTPUT R, L sockets**

These XLR sockets allow you to connect mixer, powered speakers or amp (p. 10). This output is always works as MAIN.

**18 DAMPER PEDAL**

Use this pedal to sustain the sound (p.53).

**NOTE**

We suggest to connect at this socket a continuous pedal controller as the Dexibell CPI pedal. In this way you can appreciate all the musical nuances of a continuous controller.

**19 ASSIGN PEDAL (EXPRESSION)**

Connecting a commercially available pedal to this socket allows you to control an assignable function by foot (p. 53).

This socket recognize an expression pedal connected setting automatically the Expression function, regardless of the current function assigned.

**20 MIDI THRU/IN sockets**

You can connect the IN socket to the OUT socket of a MIDI keyboard. See p. 18.

Thanks to the MIDI THRU socket you can cascade several devices in a MIDI chain.

**21 USB Computer (AUDIO/MIDI) Port**

Use an A→B-type USB cable to connect the VIVO SX8 to your computer via this port (p. 18). You'll be able to use your AUDIO/MIDI DAW software to record and play audio data.

The VIVO SX8 can transmit/receive MIDI messages and audio streaming at 24 bit 48 KHz.

# 4 Examples of Connections

## Basic Connection

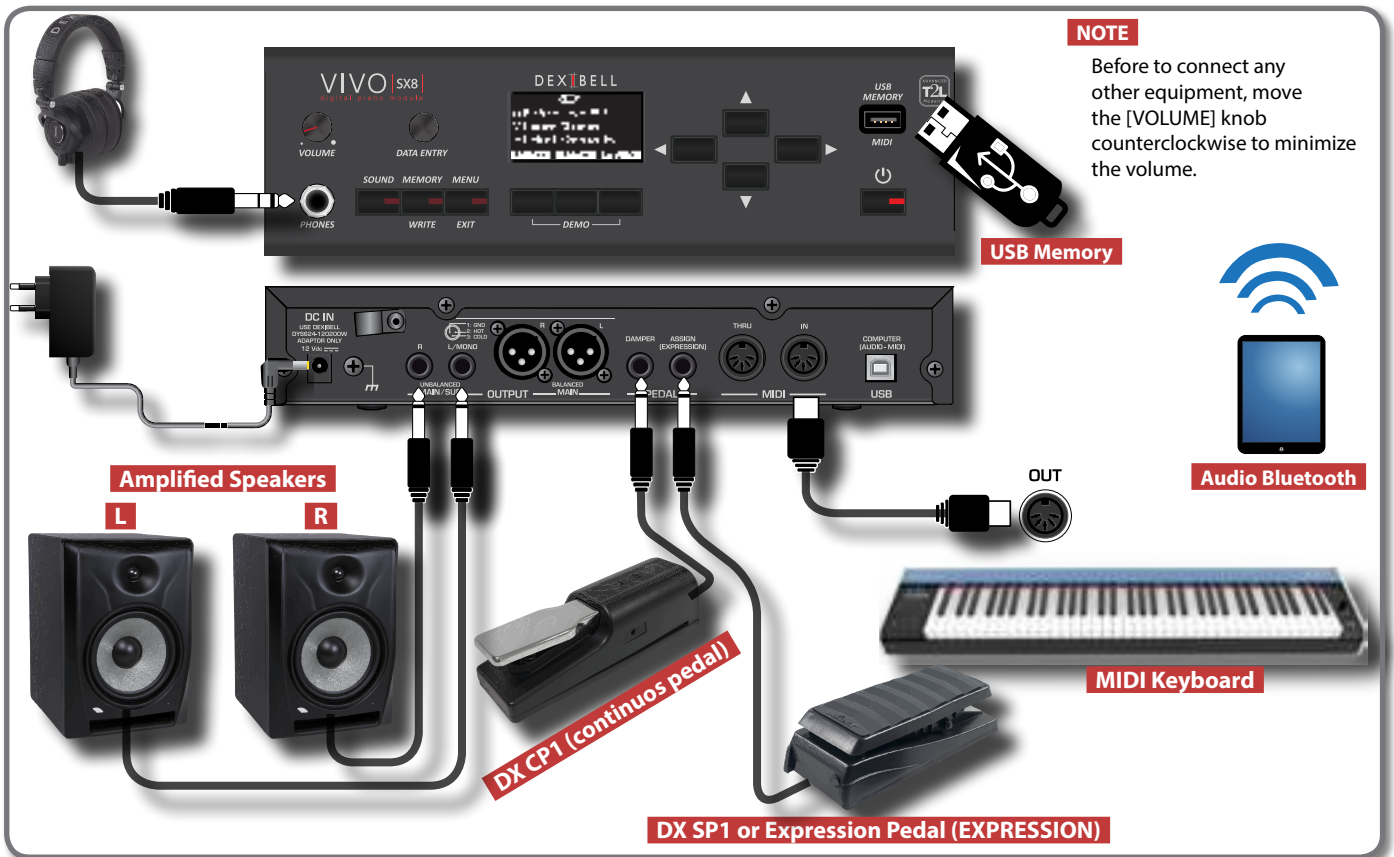

## Studio Connection

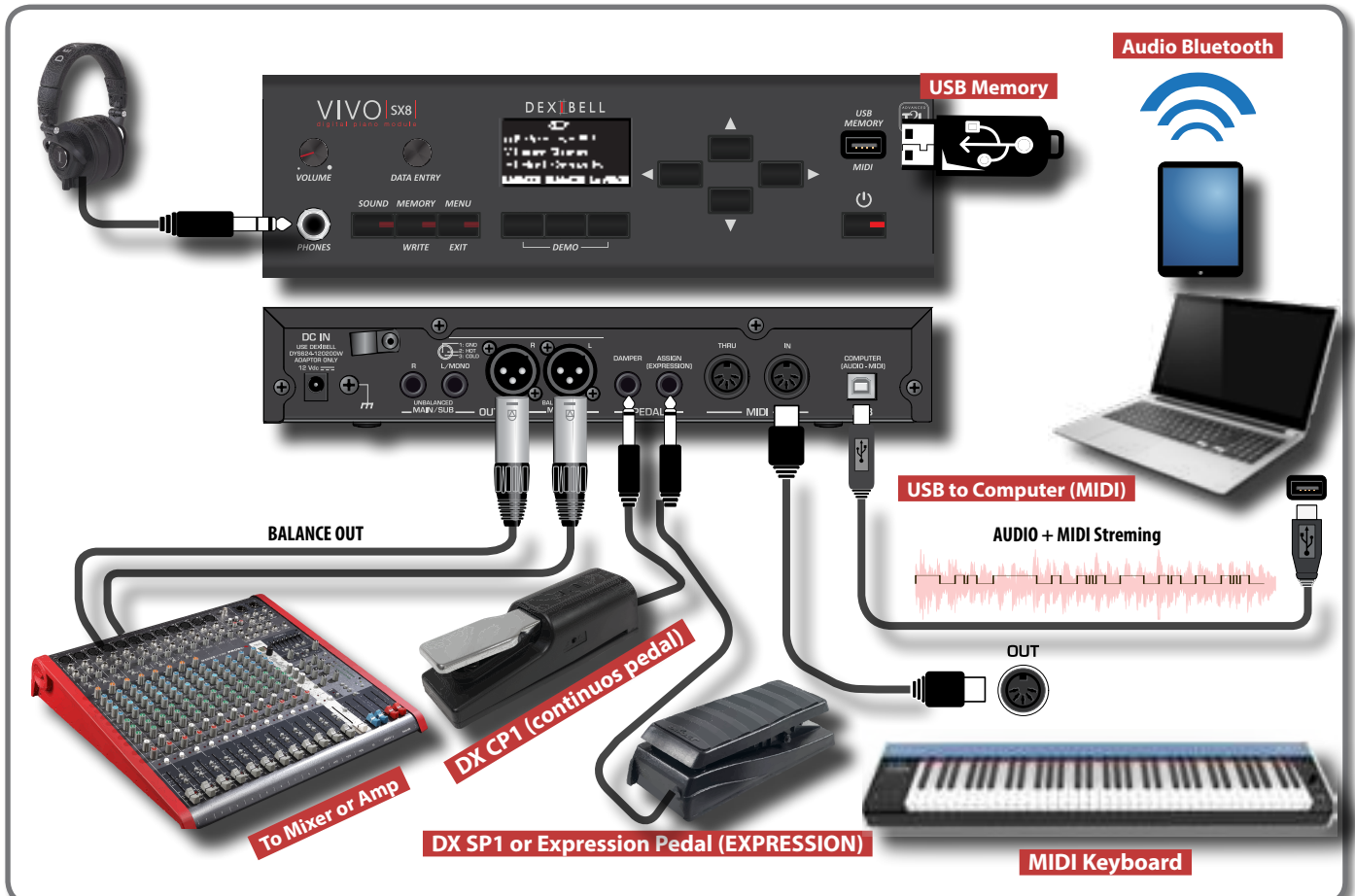

# 5 Quick Guide Basic Operations

This section explains the basic button operations used to operate the VIVO SX8.

### DATA ENTRY

- Use it to scroll items through a list and change the value of the parameters.

### MENU/EXIT

- Press this button to open and close the menu page where you can view and select all available functions.

### Arrows Button

- Master Page



- Use the [▲] [▼] buttons to select the current part (1,2 or 3).
- Use the [◀] [▶] to select the next or previous sound of the current part.

- Other Page



- Use the [▲] [▼] buttons to move the cursor up or down.
- Use the [▶] button to access to access in a submenu.
- Use the [◀] [▶] buttons to edit the parameters value.

### Sounds List

Press this button to access the Sounds List.  
The family and the current sound of the selected part is temporary showed.

- Use the [DATA ENTRY] knob or the [▲] [▼] buttons to scroll and select sounds in the list.
- Press the [◀] [▶] buttons to select the next or previous sound family.

### Function Buttons

Press these buttons to select functions/options shows at the bottom of the display.

### Favorite Settings

- HOW TO MEMORIZE YOUR FAVORITE SETTING

The VIVO SX8 allows you to memorize your favorite settings for easy recall whenever they're needed. Up to 80 complete setups can be saved.

- Press and hold the [MEMORY/WRITE] button to call up the memories page. Its indicator flashes.
- Use the [DATA ENTRY] knob or the [▲] [▼] buttons to select one of the memory location.
- Press the function button that shows "SAVE" at the bottom of the display.
- Use the [▲] [▼] and [◀] [▶] buttons to enter the desired name.
- To confirm press the function button that shows "OK" at the bottom of the display.

- HOW TO RECALL YOUR FAVORITE SETTING

- Press the [MEMORY/WRITE] button to call up the memories page.
- Use the [DATA ENTRY] knob or the [▲] [▼] buttons to select one of the memory location.
- Press the "RECALL" function button under the display to select the memory.

# 6 Before You Start to Play

## Connecting the AC Adaptor

The VIVO SX8 is an electronic instrument that requires some form of electrical power. You can power your VIVO SX8 using the supplied adaptor.

1. Rotate the [VOLUME] knob counterclockwise to minimize the volume.
2. Connect the AC adaptor to VIVO SX8's DC IN jack positioned to the rear bottom panel.

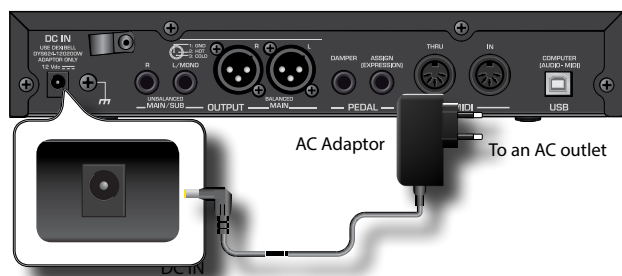

### NOTE

Be sure to use only the AC adaptor (DEXIBELL DYS624-120200W, supplied with the unit). Also, make sure the line voltage at the installation matches the input voltage specified on the AC adaptor body. Other AC adaptors may use a different polarity, or be designed for a different voltage, so their use could result in damage, malfunction, or electric shock.

### NOTE

If you won't be using the VIVO SX8 for an extended period of time, disconnect the power cord from the electrical outlet.

### NOTE

To avoid malfunctions, never disconnect the AC/DC adaptor while the instrument is turned on.

3. Plug the AC Adaptor into a power outlet.

## Secure the AC Adaptor

To avoid accidental disconnects of the power connector, secure the cable to the clamp.

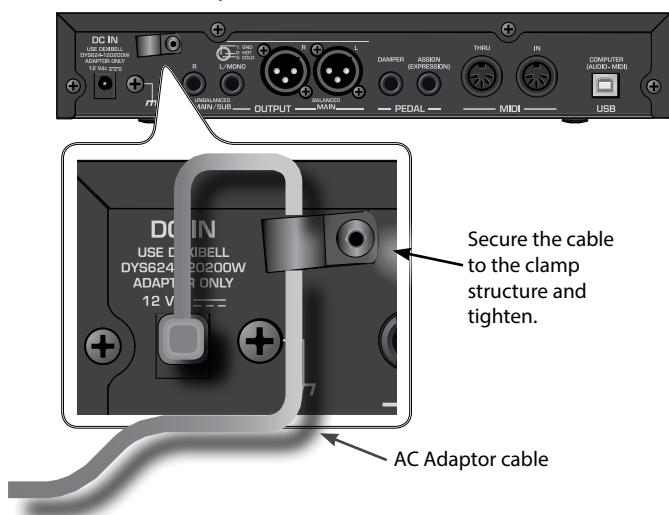

## Connecting External Audio Amplifier

You can connect the unbalanced or balanced OUTPUT R L/MONO jacks to an external amplifier, mixing consoles, etc.

All parts of the instrument can be routed to the different outputs (MAIN or SUB) as desired. For details see "Specifying the Audio Output for Each Part" (p. 28).

### NOTE

If you want to use only one channel on your external amplifier, connect the L/MONO TS socket. For optimum sound quality, we recommend working in stereo, though.

1. Rotate the [VOLUME] knob toward the left position to minimize the volume.
2. Connect the VIVO SX8's OUTPUT jacks to the inputs of your external audio device.



## About the Pedals

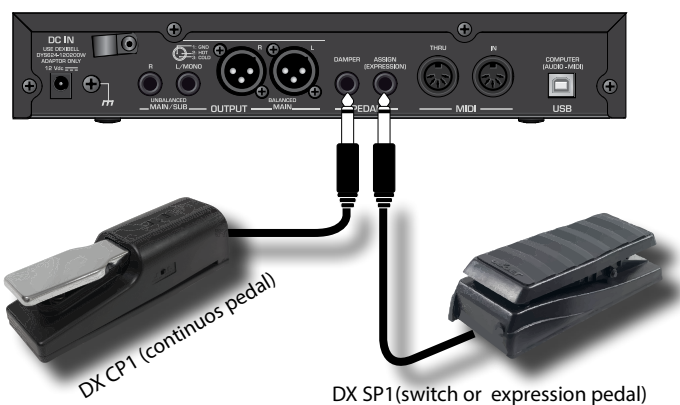

1. Connect to the DAMPER socket a sustain pedal.

This is the most commonly used pedal in a digital piano. When pressed, all notes played will continue to sound until the vibration naturally ceases.

### A MOST IMPORTANT THING TO KNOW

To have a complete simulation of damped strings of an acoustic piano appreciating all the musical nuances, we suggest to connect, at the DAMPER socket, a continuous pedal controller instead of an on/off pedal.

#### NOTE

The DAMPER socket accepts both types of pedals, continuous or foot-switch (ON/OFF type).

### 2. Connect to the PEDAL ASSIGN socket an Expression pedal.

This pedal is useful to control different aspects of the sound, commonly volume. It's used for organs, strings sounds, etc.

### Automatic recognition of an EXPRESSION pedal

The PEDAL ASSIGN socket recognizes whether an expression pedal has been connected and automatically sets the Expression function, regardless of the currently assigned function.

If you connect a continuous control pedal and the "Expression" function is active (default), you can control the volume of the Organ, Orchestra and Piano sections. To assign other functions, please refer to "EXPRESSION PEDAL" (p. 53).

If you connect a foot-switches ON/OFF type see "PEDAL ASSIGN" (p. 53).

#### NOTE

The PEDAL ASSIGN socket accepts both types of pedals, continuous or foot-switch (ON/OFF type). If you connect a continuous pedal, it's automatically recognized as Expression pedal.

## Listening Through Headphones

You can use headphones to enjoy the VIVO SX8 without disturbing those around you.

### 1. Here you can connect stereo headphones.



### 2. Rotate the VIVO SX8's [VOLUME] knob to adjust the volume of the headphone.

#### Cautions when using headphones

- To prevent damage to the cord's internal conductors, avoid rough handling. When using headphones, mainly try to handle either the plug or the headset.
- Your headphones may be damaged if the volume of a device is already turned up when you plug them in. Minimize the volume before you plug in the headphones.

- Excessive input will not only damage your hearing, but may also strain the headphones. Please enjoy music at a reasonable volume.

## Connecting an USB Memory (commercially available)

### 1. Plug an USB Memory to the MEMORY port on the VIVO SX8's panel.



#### NOTE

Carefully insert the USB Memory making sure that the connector on the device is appropriate and that it is connected in the proper direction.

#### NOTE

The VIVO SX8 supports all USB memory (FAT 32 formatted). Anyway, because there are so many USB memory on the market and it is almost impossible to check all types of memories, it could happen that a memory is not compatible with your instrument.

## How to Format the USB Memory

1. Press the "MENU" button.
2. Use the [▲] [▼] buttons to select the "USB MEMORY" functions group and press the [▶] button to access them.



3. Use the [▲] [▼] buttons to select "FORMAT" and press the [EXECUTE] Function button to access the function.

The display shows:

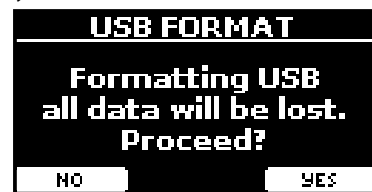

1. Press the "YES" Function button to format the USB Memory.

A confirmation message informs you that the USB memory has been formatted.

## Safely Remove the USB Memory

**NOTE**

You should always safely eject the USB Memory before physically unplugging it from USB socket. Before to unplug the USB Memory use the "USB REMOVE" function.

1. Press the [MENU/EXIT] button.
2. Use the [▲] [▼] buttons to select the "USB MEMORY" functions group and press the [▶] button to access them.



3. Use the [▲] [▼] buttons to select "REMOVE" and press the [EXECUTE] Function button to access the function.

The display shows:



4. Press the "YES" Function button to safely remove the USB Memory.

Now you can unplug the USB Memory safely.

## Ground Terminal

Depending on the circumstances of a particular setup, you could feel a tingling sensation at the point where touch this device.

You can eliminate this sensation connecting the ground terminal with an external ground.

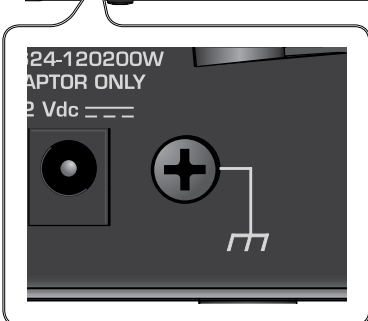

1. Use the screw-type ground terminal to connect to ground or to connect to the chassis of the mixer, preamp, or other device in your system.

## Turning the Power On/Off

Once everything is properly connected, be sure to follow the procedure below to turn on their power.

1. Rotate the [VOLUME] knob counterclockwise to minimize the volume.

**NOTE**

Before turning the VIVO SX8 on/off, always be sure to turn the volume down. Even with the volume turned down, you might hear some sound when switching the VIVO SX8 on/off. However, this is normal and does not indicate a malfunction.

2. Press the VIVO SX8's [⏻] button located on the right panel to switch it on.

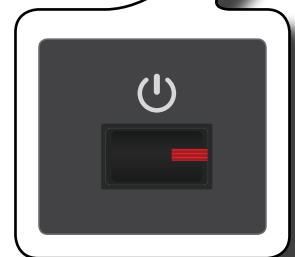

The power will turn on, a progress bar appear in the VIVO SX8's display.



After a brief interval, the main page will appear. and VIVO SX8 will be ready to produce sound.

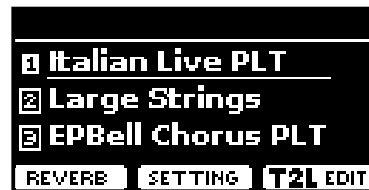

3. Use the [VOLUME] knob to adjust the volume.

**NOTE**

This unit is equipped with a protection circuit. A brief interval (a few seconds) after power up is required before the unit will operate normally.

## Turning the Power Off

1. Rotate the [VOLUME] knob counterclockwise to minimize the volume.

**NOTE**

To avoid malfunctions, never disconnect the AC/DC adaptor while the instrument is turned on.

2. Press the VIVO SX8's [⏻] switch.

A power off confirmation message appears:

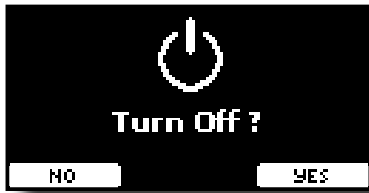

**NOTE**

All rights reserved. Unauthorized use of this material for purposes other than private, personal enjoyment is a violation of applicable laws.

**3. Press the "YES" Function button to confirm.**

The display shows the following message:



and the unit will turn off after few seconds.

If you do not want power off press the "NO" Function button.

**NOTE**

If you need to turn off the power completely, first turn off the [P] button, then unplug the power cord from the power outlet. Refer to "Connecting the AC Adaptor" (p. 12).

**If you do not operate the unit for a certain period of time while the power is on, this unit turns off automatically.**

**If you don't want the power to turn off automatically, turn the "AUTO OFF" setting off!**

**With the factory settings, the unit's power will automatically be switched off 120 minutes after you stop playing or operating the unit.**

Shortly before the VIVO SX8 shuts down automatically, the display starts counting down the seconds. If you want to keep using the VIVO SX8 at this stage, press any button.

If you don't want the power to turn off automatically, change the "AUTO OFF" setting to "OFF" as described on p. 57.

## Demo of the VIVO SX8

Your VIVO SX8 contains a demo that introduces all the best of its tones.

**1. Simultaneously press the first and the last Function button.**



Playback starts automatically with the demo song.

**2. Press the [MENU/EXIT] button to leave the demo function.**

# 7 Basic Operation





## About the Display and Cursor Operation

This section introduces the information that appear on the main page. Moreover this section illustrates how to navigate the menu.

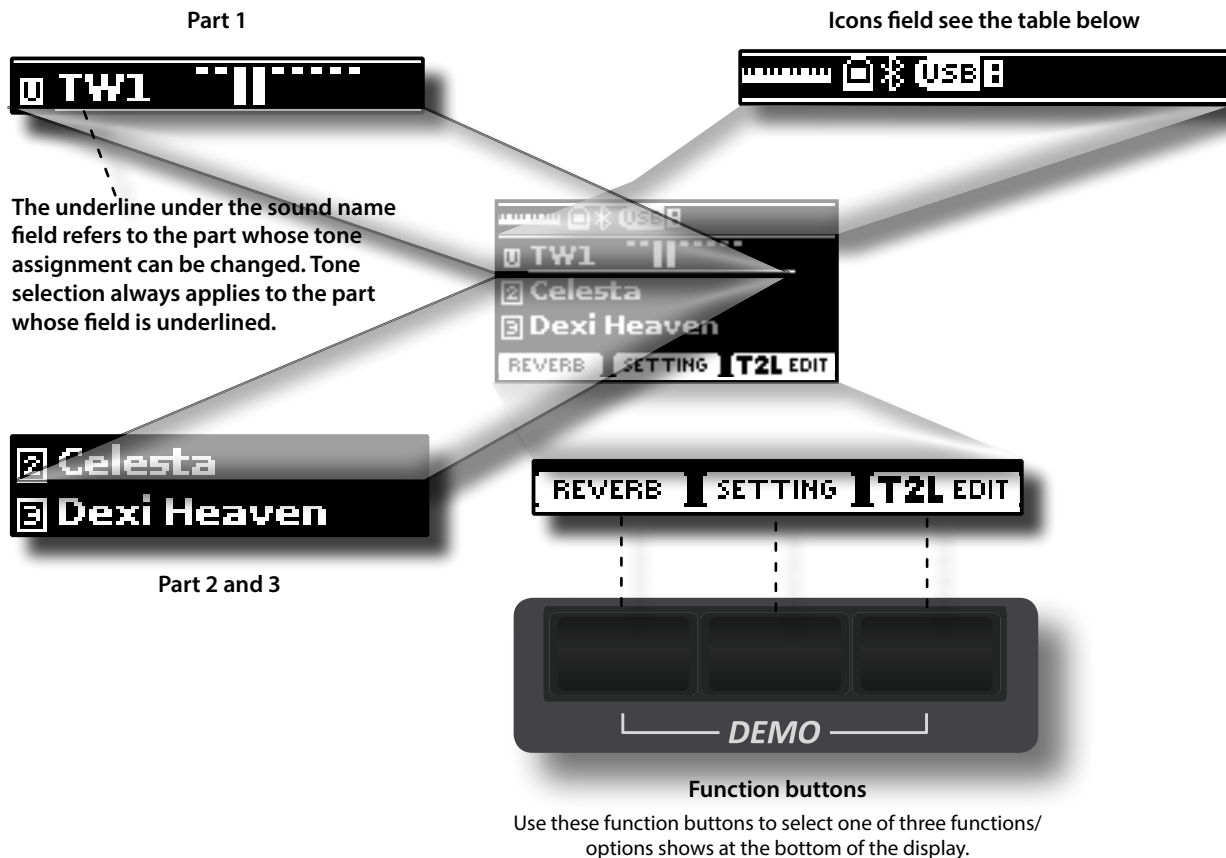
### Main Page

The VIVO SX8 main page contains many useful information.



Icons Field	Explanation	Icons Field	Explanation
	An USB MIDI keyboard is connected to the VIVO SX8's USB "MEMORY" port.		Bluetooth indicator • Steady icon: Connected to a device.
	A computer is connected to the VIVO SX8's USB "COMPUTER" port.		A USB memory is connected to your unit.



## Moving the cursor and setting parameter values

1. Press the [MENU/EXIT] button to access to the available function groups.



2. Use the [DATA ENTRY] knob or the [▲][▼] buttons to select the desired function group.

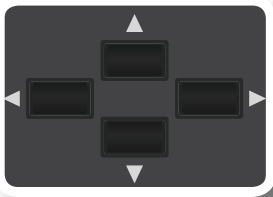

3. Press the [▶] button to enter in the selected function group.



If the functions are grouped under others groups:

4. Use the [DATA ENTRY] knob or the [▲][▼] buttons to scroll the list of groups of parameters.
5. Press the [▶] button to enter in the selected under group.
6. Use the [▲][▼] buttons to scroll the list of parameters. The selected parameter field is highlighted.
7. Use the [DATA ENTRY] knob to set the desired value.

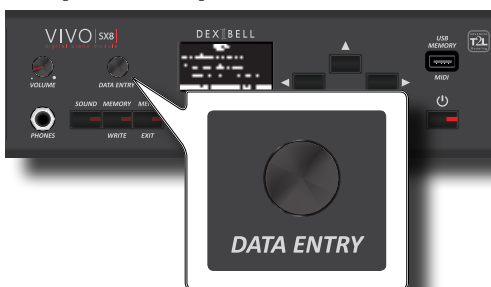

8. Press the [MENU/EXIT] button to return to the main page.

## Assigning the Name You Specify

In many cases you'll have to assign a name to a file. In the following example, we will learn how to give a Memory name.

After the selection of saving a Memory, the display looks as follows:



A Memory name is suggested by the VIVO SX8.

1. Use the [DATA ENTRY] knob or the [▲][▼] buttons to select a different character.
2. Use the [◀][▶] buttons to select the next character position you want to change, then use the [▲][▼] buttons again.
3. You can press the [A/a/#] Function button to switch between upper- and lower-case characters as well as numbers.

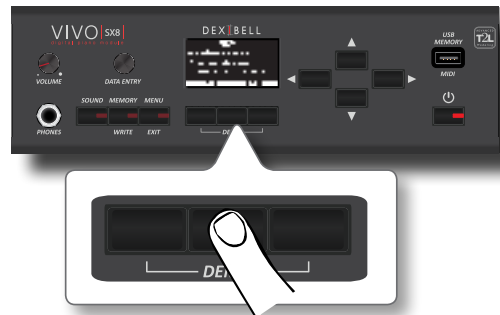

4. To delete the selected character, simultaneously press the central and right Function button.

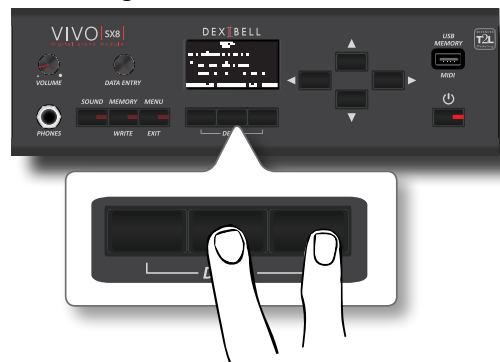

5. To insert a character, simultaneously At the same press the left and central Function button.

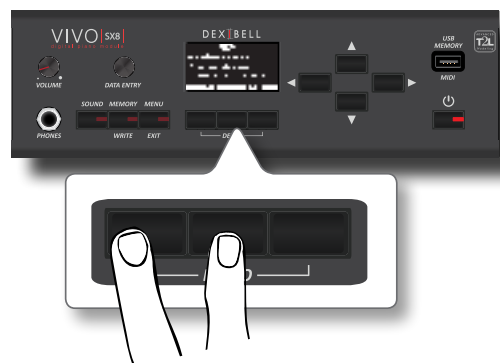

6. Repeat steps (2) and (3) to complete the name.

# 8 Main Connections

The VIVO SX8 allows you to connect an external keyboard through two ways, via MIDI or via USB.

## Connect a MIDI Keyboard

You can use a MIDI keyboard to control your VIVO SX8.

If you connect your computer to the VIVO SX8 as shown in the illustration, you'll be able to use the VIVO SX8 as a MIDI interface.

The MIDI messages received from the VIVO SX8's MIDI IN will be directly redirected to the its USB COMPUTER port together with the audio generated by VIVO SX8. Audio streaming and MIDI through the same cable.

1. Rotate the [VOLUME] knob counterclockwise to minimize the volume.
2. Use a MIDI cable (commercially available) to connect the VIVO SX8's MIDI IN socket to the MIDI OUT socket of the external MIDI keyboard.



3. If you want to work with a DAW software, use a A→B-type USB (commercially available) cable to connect the VIVO SX8's USB COMPUTER PORT to the USB port of your computer.

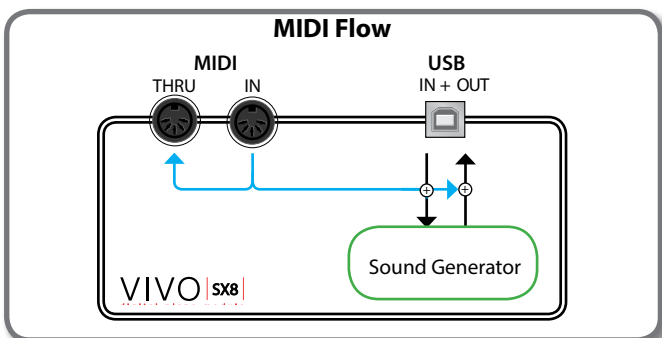

## Connect a USB MIDI Keyboard

You can use a USB MIDI keyboard to control your VIVO SX8.

If you connect your also your computer to the VIVO SX8 as shown in the illustration, you'll be able to use the VIVO SX8 as a MIDI interface.

The MIDI messages received from the VIVO SX8's USB MEMORY socket will be directly redirected to the its USB COMPUTER port.

1. Rotate the [VOLUME] knob counterclockwise to minimize the volume.
2. Use a A→B-type USB (commercially available) to connect the VIVO SX8's USB MEMORY socket to the USB socket of the external MIDI keyboard.



3. If you want to work with a DAW software, use a A→B-type USB (commercially available) cable to connect the VIVO SX8's USB COMPUTER PORT to the USB port of your computer.



## Matching MIDI Channels

The VIVO SX8 has three parts. For each part you can change the MIDI channel to match them with the device you connected.

Here below the list of MIDI channels for each part:

Part	MIDI RX channel (default)
PART 1	1
PART 2	2
PART 3	3
MEMORY	15
ORGAN CONTROL	14

The MEMORY part is used to recall memories. For more information see p. 56.

The ORGAN CONTROL part is used to control the Drawbars and other parameters of Organ via MIDI. For more information see p. 26. For details on MIDI settings of the external device, refer to its

owner's manual.

## Using the VIVO SX8 with Your Computer

If you use a USB cable (commercially available) to connect the USB COMPUTER port on the VIVO SX8's panel to your computer's USB connector, you can record and play audio or MIDI data by your MIDI software (DAW software).

**NOTE**

To use the USB audio streaming you need of a computer equipped with MAC OSX or LINUX, an iPad or iPhone.



1. Use a A→B-type USB cable (sold separately) to connect the VIVO SX8 to your computer.

**NOTE**

- Switch on the VIVO SX8 before you start up the DAW software on your computer.
- Before to connect any other equipment, move the [VOLUME] knob counterclockwise to minimize the volume.

The sound of the VIVO SX8 can now be recorded on your computer and the audio output of the computer can be reproduced by the audio system connected to the VIVO SX8's audio OUTPUT jacks.

**NOTE**

To use the USB audio streaming you need of a computer equipped with MAC OSX or LINUX, an iPad or iPhone.

## Adjusting the USB Audio

Use this function if you need to adjust the audio output and input levels via USB.

1. Press [MENU/EXIT] button and select USB AUDIO function.



2. Use the [▲] [▼] buttons to select the parameter you want to edit.
3. Use the [DATA ENTRY] knob to choose the desiderate audio level.

Parameter	Setting	Explanation
Input Level	-inf~0 dB	Adjust the USB audio input level.
Output Level	-inf~0 dB	Adjust the USB audio output level.

## USB Audio Feature

Thanks to the USB audio you can record the audio of the VIVO SX8 directly without using any internal digital analogue converter. This greatly increases audio quality and noise immunity.

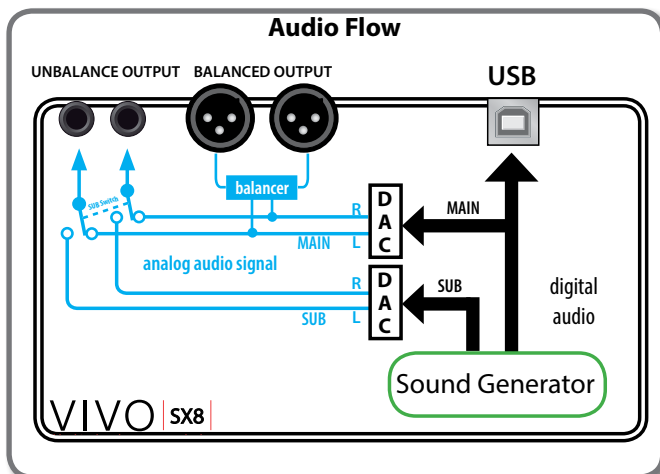

The VIVO SX8's audio format:

Sampling rate	48 Khz
Bit depth	24
Number of channel	3

# 9 Selecting the Tones

VIVO SX8 has a wide selection of high quality tones arranged in eight categories. In particular, thanks to new sound engine, the Piano tones are faithfully reproduced with all the subtle nuances of a real acoustic piano.

VIVO SX8 also includes a section that simulates famous electric organs. Some organ sounds are preset by factory and you will find them in the "ORGAN" family. For more details see "Organ Section" (p. 22).

The VIVO SX8 allows you to assign any of the available tones to any of the three real-time parts. Tone selection always applies to the part (1, 2 or 3) whose field is currently underlined in the main page.

## How to Select a Part

Before to operate a tone change you need to select on which part you want to do it.

VIVO SX8 has two sections: the orchestral section and the organ section. Depending on the selected tone, the part changes its name as follows:

Orchestral Section		Organ Section	
<b>1</b>	Part 1	<b>U</b>	Upper part
<b>2</b>	Part 2	<b>L</b>	Lower part
<b>3</b>	Part 3	<b>P</b>	Pedal part

- From the main page, use the [▲] [▼] buttons to select the part.

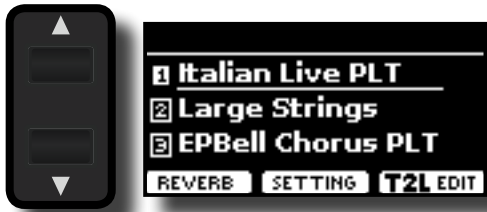

The display underline the field of the selected part.  
The tone selection is always applies to the part whose field is underlined.

## How to Select Tones

### How to Select Tones From the Main Page

- Use the [DATA ENTRY] knob or the [◀] [▶] buttons to scroll through the list of the sounds and select the desired sound.



## Selecting Tones from a Tone List by the [SOUND] Button

- Press the [SOUND] button.



The [SOUND] indicator lights and a temporary page shows the list of the sounds of the selected part, the current sound is underlined:



When the selected part contains an organ sound:

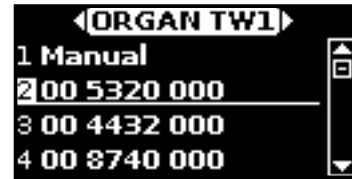

For more information about the selection of organ sounds, see "Organ Section" (p. 22).

- While the page is active, use the [DATA ENTRY] knob or the [▲] [▼] buttons to select a tone in the same sound family.

If during normal operation the window closes automatically, press the [SOUND] button again.

See "VIVO SX8's Tone List" (p. 61).

- While the page is active, press the [◀] [▶] buttons to select the previous or next sound family.

After few seconds of inactivity of the change tone operation, the Main page is shown.

#### TIPS

A quick way to change a tone from the Main page: use the [DATA ENTRY] knob or the [◀] [▶] buttons to select a next or previous tone.

## How to Reorder the Tone List

Use this function if you need to reorder the tones list. If you wish, you can move the position of the individual tone in the list.

- Press the [MENU/EXIT] button and select SOUND LIST.



The display shows the tone list.



- Use the the [DATA ENTRY] knob or the [▲][▼] buttons to select the tone you want to reorder.

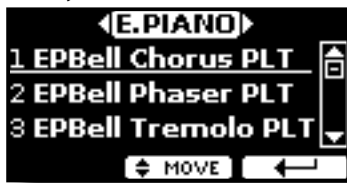

- Press the "MOVE" function button.

An  symbol appears to the left of the selected tone.



- Use the [DATA ENTRY] knob or the [▲][▼] buttons to select the new position where you want to move the selected tone. If you want move the tone in another category use the [◀][▶] buttons.



- Press the "OK" Function button to confirm the operation.

Press "CANCEL" Function button to cancel the operation.

## Tone MIDI Information

Tones can also be selected via USB MIDI. To this effect, they use an "internal" address, which is not usually displayed. For MIDI applications involving sequencers or external controllers, knowing the "official" address may come in handy. The VIVO SX8 has an handy system that provides this information instantly—there is thus no need to look up the MIDI address in the tones list at the end of this manual.

- Press the [SOUND] button to temporarily open the sounds list page.

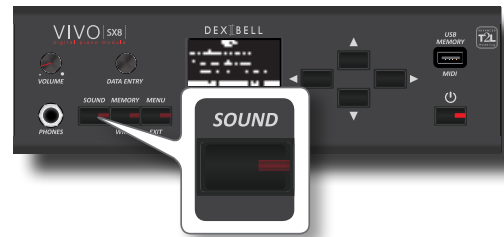

- The [SOUND] indicator lights and a temporary page shows the list of the sounds of the selected part, the current sound is underlined:



- Press one of the Function buttons located below the display.



The tone MIDI information are temporary showed:



# 10 Organ Section

The VIVO SX8 has a section that simulates famous electric organs. You can select many presetted organ sound and create a wide variety of tonalities and save them in the instrument's internal memory. You can add various typical effects of an electric organ as a Leslie speaker.

## Selecting Presetted Organ Sounds

1. Select the organ model you desired. See "Selecting Various Organ Types" (p. 22).
2. Before to operate a tone change you need to select on which part you want to do it. See "How to Select a Part" (p. 20).
3. Press the [SOUND] button.



The [SOUND] indicator lights and a temporary page shows the list of the sounds of the selected part, the current sound is underlined:



4. While the page is active, press the [◀] [▶] buttons to select the organ sound family.



The last sound you selected for the organ family is recalled.

"Manual" is the current footage configuration.

The other items of the list indicate the most used combinations. Each number indicates the amount of volume for each foot. For example, the "00 5320 000" corresponds to the following position of "virtual" drawbar:

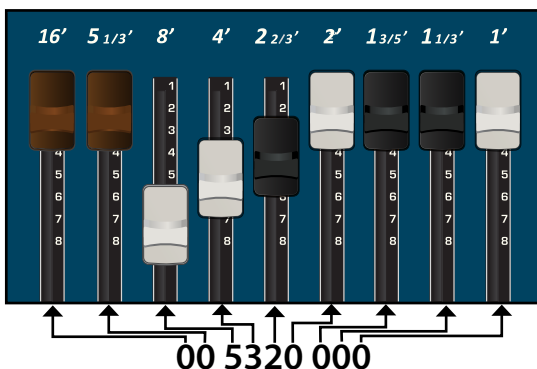

5. While the tone window is active, use the [▲] [▼] buttons to select a different preset. The preset configuration is recalled.

### MEMO

If during normal operation the window closes automatically, press the [SOUND] button again.

## Selecting Various Organ Types

The VIVO SX8 comes with various organ models that reproduce the tonal characteristics of both tonewheel and transistor types organ: TW1, TW2, FARF, VX and PIPE. Moreover you have two user organ memory location (USER 1, USER 2) that allows you to expand the tonal resources of the instrument. You can download this selection of sounds from the [www.dexibell.com](http://www.dexibell.com) website. See "How To Load Sound Libraries From a USB Memory" (p. 33).

1. Select a preset organ sound. See "Selecting Presetted Organ Sounds" (p. 22).

The display shows a page like this:



The organ tone is shown as follows:

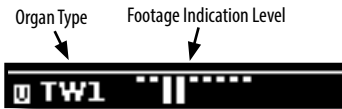

2. Press the "T2L EDIT" function button and using the [▲] [▼] buttons, select "ORGAN TYPE".

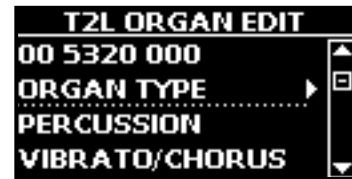

3. Press the [▶] button to access the ORGAN TYPE page.

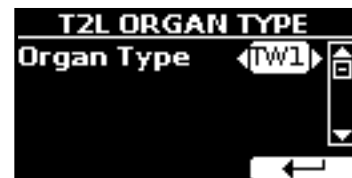

4. Use the [◀] [▶] buttons to select the desired organ type.

The selected organ type is now available for all parts.

Organ Type	Explanation
TW1	It's a simulation of a organ style cabinet that use an tonewheel apparatus for generating electric musical note.
TW2	It's a simulation of an "home organ" style cabinet with some built-in speakers" that use an tonewheel apparatus for generating electric musical note.
FARF	This is a simulation of a portable transistors-based organ.
VX	This is a simulation of transistor-based combo organ.

Organ Type	Explanation
PIPE	This simulate a pipe organ. It's a musical instrument that produces sound by driving pressurized air through organ pipes.
USER1	You can download sounds from the <a href="http://www.dexibell.com">www.dexibell.com</a> website.
USER2	See "Additional Sound (Sound Library)" (p. 32).

## How to Set Up Your Footage Configuration Starting From an Organ Preset

1. Select a preset organ sound. See "Selecting Presetted Organ Sounds" (p. 22).

The display shows a main page like this:



The organ tone is shown as follows:

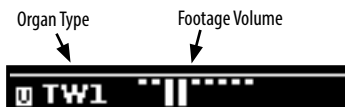

2. Press the "T2L EDIT" function button and using the [▲] [▼] buttons select the organ tone (first row). The numbers indicate the volume for each footage.

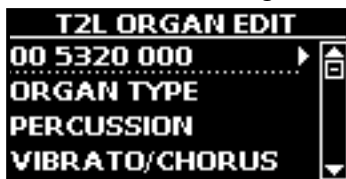

3. Press the [▶] button to access the "DRAWBAR" editing page.



The page shows the volume of each footage.

4. Use the [◀] [▶] buttons to select the previous or next footage.
5. Use the [DATA ENTRY] knob or the [▲] [▼] buttons to increase the volume in incremental steps from 0 (no sound) to 8 (maximum volume).
6. Press the [FULL] function button to move the drawbar down (maximum volume).

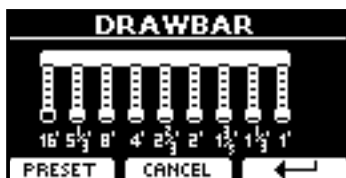

7. Press the [CANCEL] function button to move the drawbar

up (minimum volume).



8. Press the "PRESET" function button to select another organ preset. This shortcut is useful for recalling another preset without exiting the drawbar edit page.



### NOTE

Attention, changes may be lost if you recall another preset. If you wish, you can save your configuration in a memory and then recall it at another time. See "Saving Your Settings in the Internal Memory" (p. 42).

## Adding Harmonic Percussion

It's the classic crisp attack unique to the vintage organ. This effect was designed to emulate the percussive sounds of the harp, xylophone and marimba. When the percussion is selected, this feature adds a decaying second- or third-harmonic overtone when a key is pressed.

### NOTE

The harmonic percussion feature is available for the TW1 and TW2 organ type and only on the MAIN or LOWER keyboard part.

1. From the "T2L ORGAN EDIT" page, use the [▲] [▼] buttons to select "PERCUSSION".

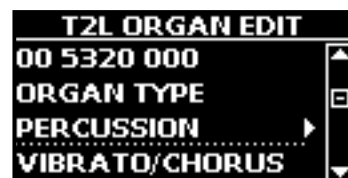

2. Press the [▶] button to access the "PERCUSSION" page.

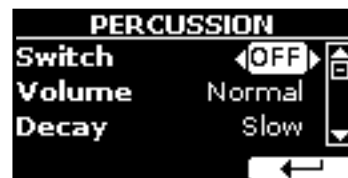

3. Use the [▲], [▼] buttons to select the parameter and use the [DATA ENTRY] knob or the [◀] [▶] buttons to adjust the value. See "Moving the cursor and setting parameter values" (p. 17).

Parameter	Setting	Explanation
Switch	OFF, ON	Select "ON" to activate the effect.
Volume	Normal, Soft	Select between a "Normal" or "Soft" percussion levels.
Decay	Slow, Fast	Select between a "Slow" or "Fast" decay.
Harmonic	3rd, 2nd	Select to add a "3rd" or "2nd" harmonic to the percussion.

**NOTE**

Attention, changes may be lost if you recall another preset. If you wish, you can save your configuration in a memory and then recall it at another time. See "Saving Your Settings in the Internal Memory" (p. 42).

This menu item is not present if a pipe type organ is selected.

## Applying Vibrato/Chorus Effect

The VIVO SX8 has a vibrato effect and a chorus effect to enrich your performances. The vibrato and chorus system consists of six settings, V1, V2, V3, C1, C2 and C3 (i.e., 3 vibrato and 3 chorus), which can be selected from the "VIBRATO / CHORUS" page in the "T2L EDIT" environment.

1. From the "T2L ORGAN EDIT" page, use the [▲][▼] buttons to select "VIBRATO/CHORUS".

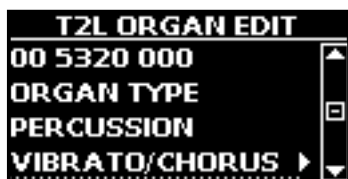

2. Press the [▶] button to access the "VIBRATO/CHORUS" page.



3. Use the [▲], [▼] buttons to select the parameter and use the [DATA ENTRY] knob or the [◀] [▶] buttons to adjust the value. See "Moving the cursor and setting parameter values" (p. 17).

Parameter	Setting	Explanation
Switch	OFF, ON	Select "ON" to activate the effect.
Type	V1,C1	Vibrato or Chorus light depth effect.
	V2, C2	Vibrato or Chorus standard depth effect
	V3,C3	Vibrato or Chorus deepest effect
Upper	OFF, ON	Select "ON" to activate the effect for the Upper part.
Lower/Pedal	OFF, ON	Select "ON" to activate the effect for the Lower/Pedal parts.

**NOTE**

Attention, changes may be lost if you recall another preset. If you wish, you can save your configuration in a memory and then recall it at another time. See "Saving Your Settings in the Internal Memory" (p. 42).

## Adding Overdrive Effect

This is the typical effect of vacuum tube amplifier and it is achieved by "overdriving" the valves.

**NOTE**

1. From the "T2L ORGAN EDIT" page, use the [▲][▼] buttons to select "OVERDRIVE".

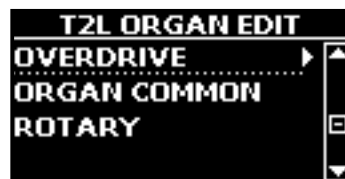

2. Press the [▶] button to access the "OVERDRIVE" page.



3. Use the [▲], [▼] buttons to select the parameter and use the [DATA ENTRY] knob or the [◀] [▶] buttons to adjust the value. See "Moving the cursor and setting parameter values" (p. 17).

Parameter	Setting	Explanation
Switch	OFF, ON	Select "ON" to activate the effect.
Drive	1~100	Adjust the amount of effect. Also changes the volume.
Tone	1~100	Adjusts the tonal quality of the sound.
Level	1~100	Use this parameter to compensate for exaggerated level differences resulting from the settings you made.
Eq Low freq	80 ~ 400 Hz	Selects the frequency of the low range.
Eq Low gain	-12dB~0~12dB	Gain of the low frequency range.
Eq High freq	800Hz ~ 8KHz	Selects the frequency of the high range.
Eq High gain	-12dB~0~12dB	Gain of the high frequency range.

**NOTE**

Attention, changes may be lost if you recall another preset. If you wish, you can save your configuration in a memory and then recall it at another time. See "Saving Your Settings in the Internal Memory" (p. 42).

## Organ Common Parameters

This session contains a series of parameters common to all tonewheel (TW) type organs. It also contains some parameters for other organ types.

1. From the "T2L ORGAN EDIT" page, use the [▲][▼] buttons to select "COMMON".



2. Press the [▶] button to access the "COMMON" page.





3. Use the [▲], [▼] buttons to select the parameter and use the [DATA ENTRY] knob or the [◀] [▶] buttons to adjust the value. See "Moving the cursor and setting parameter values" (p. 17).

For details about the common parameters refer to "Organ Common" (p. 39).

## Adding Rotary Effect

This effect simulates the typical sound modulation generated by a cabinet with rotating loudspeakers.

### NOTE

This menu item is not present if a pipe type organ is selected.

1. From the "T2L ORGAN EDIT" page, use the [▲] [▼] buttons to select "ROTARY".



2. Press the [▶] button to access the "ROTARY" page.

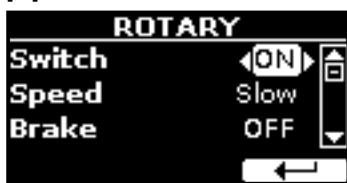

3. Use the [▲], [▼] buttons to select the "Switch" parameter and use the [DATA ENTRY] knob or the [◀] [▶] buttons to select "ON" to add the rotary effect.
4. Use the [▲], [▼] buttons to select the "Speed" parameter and use the [DATA ENTRY] knob or the [◀] [▶] buttons to select between the fast or slow speed.
5. Use the [▲], [▼] buttons to select the "Brake" parameter and use the [DATA ENTRY] knob or the [◀] [▶] buttons to stop the rotation of the rotary. When this is turned "ON", the rotation will gradually stop. When it is turned "OFF", the rotation will gradually resume.

For more details see "Rotary" (p. 40).

# 11 Parts & MIDI Settings

## Part Settings

For each part you can edit settings such as volume (Level), Panpot, Octave and key range.

1. In the main page, press the "SETTING" Function button to open the "PART1 SETTING" page.



2. Use the [▲] [▼] buttons to select the parameter that you want to edit.  
The selected parameter field is highlighted.

3. Use the [DATA ENTRY] knob or the [◀] [▶] buttons to edit the value.

4. Press the "PART 2" or the "PART 3" Function button to access the related parameters

### PART 1-3

Parameter	Setting	Explanation
Level	0 ~ 127	Adjusts the volume of the parts. Selecting "0" means that the part in question is no longer audible.
Panpot	-64 ~ 0 ~ 63	Use this parameter to set the stereo placement of the selected instrument. "0" means "no change", negative values shift the instrument towards the left, and positive values shift it towards the right.
Octave	-4 ~ 0 ~ +4	Use this parameter to transpose the selected instrument up or down by up to 4 octaves.
Mute	OFF, ON	Select "ON" to mute the part.
Coarse Tune	-24 ~ 0 ~ +24	The Coarse and Fine Tune are used to create interference pattern between two sounds of slightly different frequencies. Changes the pitch in semi-tone steps.
Fine Tune	-99 ~ 0 ~ +99	Changes the pitch in steps of 1 cent (1/100 semi-tone).
Note Low	A0~ C8	You can set the range note for the part.
Note High	A0~ C8	
Pitch Bender Range	0, +/-24	Sets the value of the PB range (received from midi) on the selected part.

## Transposing the Pitch of the Parts

The transpose setting allows the pitch of your VIVO SX8's parts to be raised or lowered in semi-tone steps.

This is particularly useful when accompanying instruments tuned for different keys, or when a song learned in one key must be played in another key or when a singer sing in a key different than the original music.

1. Select: [MENU] button →SETTING→TRANPOSE.
2. Use the [DATA ENTRY] knob to adjust the transposition value.

### "Transpose" setting

-12 ~ 0 ~ +12 (semitone units)

## MIDI Settings

MIDI (*Musical Instrument Digital Interface*) is a standard specification that allows musical data to be transferred between electronic musical instruments and computers.

Thanks to this standard, you can transfer musical data between the VIVO SX8 and a MIDI keyboard or a personal computer. See "Main Connections" (p. 18).

With the VIVO SX8's MIDI THRU port you can cascade several devices in a chain.

The MIDI default channels for each part are the following:

Part	MIDI RX/TX channel (default)
Part1	1
Part2	2
Part3	3
Memory	15
Organ Control	14

For information regarding the "Memory" part, see p. 56.

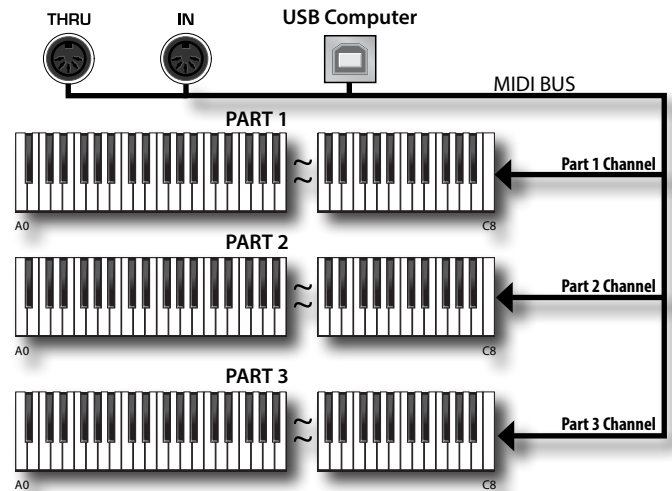

The Organ Control channel allows you to control the level of the drawbars for each part. In addition it is possible to activate and control the effects of the organ. See "Drawbars MIDI Controls" (p. 63).

## MIDI Reception

The VIVO SX8 has three parts. Each part can receive MIDI messages from a specific channel by the MIDI IN socket and the USB Computer port.

You can choose for each part the MIDI channel, filter MIDI messages, deactivate the reception of messages, etc.

1. Select: [MENU] button →MIDI. See "Moving the cursor and setting parameter values" (p. 17).



- Use the [DATA ENTRY] knob and the [▶] button to enter in the "Reception" page.

**MEMO**

Instead of [DATA ENTRY] knob, You can also use the [▲] [▼] buttons to scroll the items.

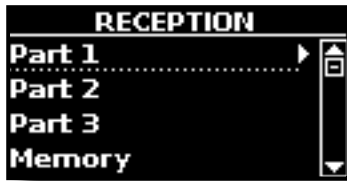

- Use the [DATA ENTRY] knob and [▶] to select the part and access the related parameters.



In the example above we selected the "Part 1".

- Use the [▲] [▼] buttons to scroll the list of parameters. The selected parameter field is highlighted.
- Use the [DATA ENTRY] knob to set the desired value.

**PART 1-3**

Part 1, Part 2, Part 3		
Parameter	Setting	Explanation
Status	OFF, ON Default: On	Select "On" if you want the selected part to receive MIDI data.
Channel	1 ~ 16	Allows you to assign a MIDI receive channel to the selected part.
Shift	-48~0~+48 Default : 0	This parameter allows you to transpose the received note messages before sending them to the VIVO SX8's sound generator. The maximum possible transposition is four octaves up (48) and down (-48). Each step represents a semi-tone.
Modulation	OFF, ON Default: On	These filters allow you to specify whether (On) or note (Off) the messages in question should be received.
Volume		
Panpot		
Expression		
Aftertouch		
Reverb		
Hold		
Sostenuto		
Soft		
PG (Program Change)		
PB (Pitch Bender)		

- Use the "PART 2" or the "PART 3" Function button to access the related parameter.
- If you selected the "Organ Control" part, the following page is showed:



Memory		
Parameter	Setting	Explanation
Status	OFF, ON Default: On	Select "On" if you want to receive drawbars MIDI messages. For details regarding the MIDI messages received, see "Drawbars MIDI Controls" (p. 63).
Channel	1 ~ 16 default: 14	Allows you to assign a MIDI receive channel to the "Organ control" part.

For information regarding the parameter of the "Memory" part, see p. 56.

**MIDI Transmission**

As you can imagine, the VIVO SX8 does not transmit notes but control MIDI messages only as Volume, Modulation, Expression, Program change, etc. by the USB port.

You can you can choose which midi events to filter.

- Select: [MENU] button →MIDI. See "Moving the cursor and setting parameter values" (p. 17).



- Use the [DATA ENTRY] knob and the [▶] button to enter in the "Transmission" page.

**MEMO**

Instead of [DATA ENTRY] knob, You can also use the [▲] [▼] buttons to scroll the items.



- Use the [DATA ENTRY] knob and the button [▶] to select the part and access the related parameters.

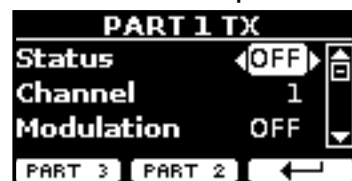

In the example above we selected the "Part 1".

- Use the [▲] [▼] buttons to scroll the list of parameters. The selected parameter field is highlighted.
- Use the [DATA ENTRY] knob to set the desired value.

**PART 1-3**

Main, Coupled, Lower		
Parameter	Setting	Explanation
Status	OFF, ON Default: ON	Select "ON" if you want the selected part to transmit MIDI data.
Channel	1 ~ 16	Allows you to assign a MIDI transmit channel to the selected part.

Main, Coupled, Lower		
Parameter	Setting	Explanation
Modulation	OFF, ON Default: OFF	These filters allow you to specify whether (ON) or note (OFF) the messages in question should be transmitted.
Volume		
Panpot		
Expression		
Aftertouch		
Reverb		
Hold		
Sostenuto		
Soft		
PG (Program Change)		
PB (Pitch Bender)		

- Use the "PART 2" or the "PART 3" Function button to access the related parameter.
- If you selected the "Organ Control" part, the following page is showed:



Memory		
Parameter	Setting	Explanation
Status	OFF, ON Default: On	Select "On" if you want transmit position MIDI messages of the drawbars. For details regarding the MIDI messages transmitted, see "Drawbars MIDI Controls" (p. 63).
Channel	1 ~ 16 default: 14	Allows you to assign a MIDI transmit channel to the "Organ control" part.

For information regarding the parameter of the "Memory" part, see p. 56.

cursor and setting parameter values" (p. 17).

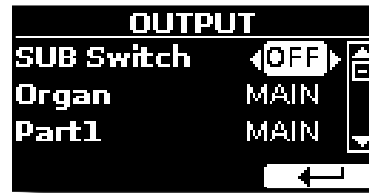

- Use the [▲][▼] buttons to select "SUB Switch" parameter and using the [DATA ENTRY] knob set the "SUB Switch" parameter to "ON".  
The MAIN/SUB unbalanced sockets are now enabled as SUB audio outputs.
- Use the [▲][▼] buttons to select the part you wish to change the output.
- Use the [DATA ENTRY] knob to set the desired output (MAIN or SUB).

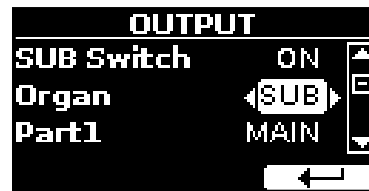

In the example above we changed the output of the Organ part.

- By performing steps 2 and 3 again you can change the output of the parts you want.

Parameter	Setting	Explanation
SUB Switch	OFF, ON default: OFF	Enable the MAIN/SUB unbalanced sockets as SUB outputs.
Organ	MAIN, SUB default: MAIN	Use this parameter to set the audio output of the part: MAIN or SUB
Part1		
Part2		
Part3		

## Specifying the Audio Output for Each Part

VIVO SX8 provides MAIN/SUB unbalanced output (TS jacks) in addition to MAIN balanced output (XLR jacks) as outputs for the signal of the audio parts.

As appropriate for your situation, you can choose which audio output to use (MAIN or SUB) for a certain part (Organ, Part1, Part2, Part3).

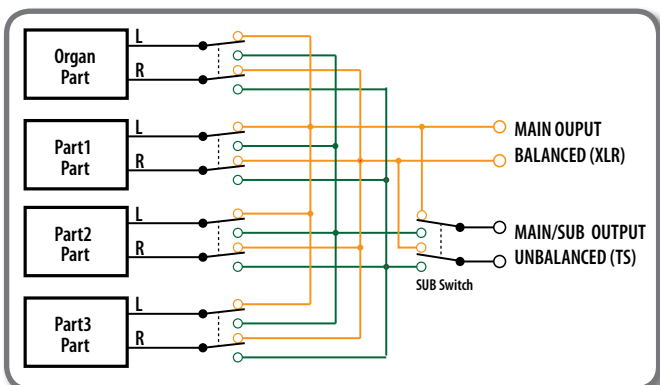

- Select: [MENU] button → OUTPUT. See "Moving the

# 12 Adding Effects to Orchestral Sound

## Going Around Sound Effects

VIVO SX8 is quite simply a superlative instrument with the most advanced and best sound generation technology Dexibell has to offer.

When you recall a Tone the instrument automatically add the appropriate effects for that sound.

Anyway, VIVO SX8 give you the possibility to change type of effect or modify some parameter of it.

VIVO SX8 manage three units of effectors (FX-A, FX-B and FX-C) for each part (Part 1, Part 2, Part 3).

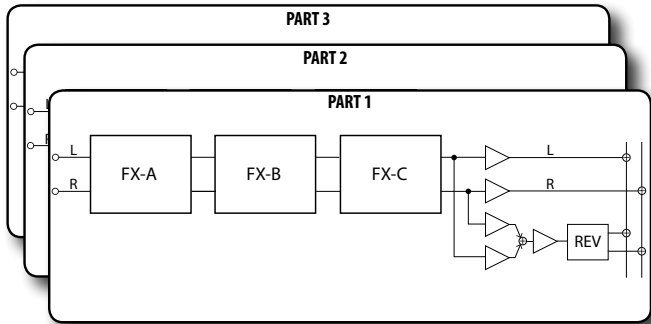

1. Select: [MENU] button → EFFECTS. See "Moving the cursor and setting parameter values" (p. 17).

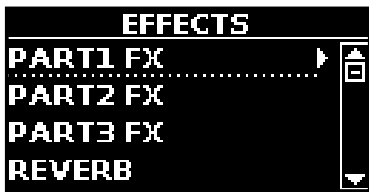

2. Use the [DATA ENTRY] knob and the button [▶] to select the part and access the related parameters.



In the example above we selected the "Part 1"

### MEMO

Instead of [DATA ENTRY] knob, You can also use the [▲][▼] buttons to scroll the items

3. Use the [DATA ENTRY] knob to choose the Type of effect. Press the "ON/OFF" Function button if you want to exclude or not the FX processor. For the list of effects see "Effects Types and Parameters List" (p. 58).
4. Use the [▲][▼] buttons to select the parameter relative to the chosen effect.
5. Use the [DATA ENTRY] knob to adjust the parameter value. For details about the parameters for each effects, see p. "Effects Types and Parameters List" (p. 58).
6. To select the other effectors, repeatedly press the middle function button.

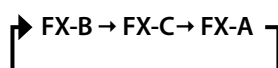
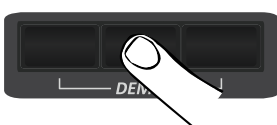

## Adding Reverb to the Sound

The reverb enables you to select various digital reverb effects that would add extra depth and expression to the sound to create a realistic acoustic ambience. You can adjust the reverb value for each part.

1. While the main page is showed, press the left Function button to access the Reverb parameters.



The display shows the Reverb page:



As you can see, you have an additional part, the ORGAN part.

The ORGAN part is the part of the tonewheel. For example, if you selected a organ tone in the Main part (see "Selecting Presetted Organ Sounds" (p. 22), to adjust the reverb you have to change the value of the ORGAN part and not the Main part.

### MEMO

You can also select this function pressing [MENU] button → EFFECTS → REVERB.

2. Use the [▲][▼] buttons to specify the part you wish to change the Reverb level.
3. Use the [DATA ENTRY] knob to adjust the Reverb level.

## Changing the Reverb Type

This parameter allows you to specify what kind of reverb effect you need.



1. While the Reverb page is displayed, press the "TYPE" Function button to access the Reverb Type page.



2. Use the [DATA ENTRY] knob to choose the Macro Type you prefer.

The available Macro reverb types are:

### Setting

Hall, Dark Hall, Mid Hall, Concert Hall, Large Hall, Chathedral, Arena, Cave, Chamber, Room, Venue, Ambience, Wooden Room, Brick Room, Studio Booth, Small Room, Living Room, Office, Warehouse, Music Club, Plate, Small Spring, Bright Spring, AmpSpring.

# 13 Other Functions

## Master Equalizer

The equalizer give you the possibility to boosting or reducing the low-frequency or high-frequency range of the sound. Adjust the Master EQ parameters to reach the best possible sound when listening through different reproduction systems, headphones, or an external speaker system.

1. Press [MENU/EXIT] button and select EFFECTS→MASTER EQ



2. Use the [DATA ENTRY] knob or the [▲], [▼] buttons to select the parameter and use the [◀] [▶] buttons to adjust the value.

Parameter	Setting	Explanation
High Gain	-12~ 0 +12 dB	Use this parameter to set the level of the high frequency. Positive values boost (increase) the volume of that frequency. Negative values cut (attenuate) it.
High Freq	400 ~ 10000 Hz	This parameter allows you to set the cutoff frequency of the high band.
Mid Freq	100 ~ 8000 Hz	This parameter allows you to set the cutoff frequency of the middle band.
Mid Gain	-12~ 0 +12 dB	Use this parameter to set the level of the selected MID frequency. Positive values boost (increase the volume of) that frequency. Negative values cut (attenuate) it.
Mid Q	0.5 ~ 12.0	Move this parameter to adjust the width of the area around the Middle frequency that will be affected by the Gain setting. Higher values of Mid Q set narrowest area
Low Gain	-12~ 0 +12 dB	Use this parameter to set the level of the low frequency. Positive values boost (increase) the volume of that frequency. Negative values cut (attenuate) it.
Low Freq	40 ~ 600 Hz	This parameter allows you to set the cutoff frequency of the low band.

## Master Equalizer Preset

VIVO SX8 comes with some Presets that can be handy in particular situations or a good way to get you started. You might want to start with a preset, then customize it until it is just right and save it in the user area.

1. From the "MASTER EQ" page press the "PRESET" Function button.



2. Use the [DATA ENTRY] knob or the [▲], [▼] buttons to select the desired preset.
3. Press the "SELECT" Function button to confirm your choice.  
Its "EQ" icon is highlighted to indicate that the preset has been loaded.

## Saving Your User Preset

Make the necessary adjustments to obtain the sound that suits you best.

1. From the "MASTER EQ" page, press the "SAVE" Function button.



2. If you wish, you can give a name to the preset pressing the "RENAME" Function button. For details how to rename see "Assigning the Name You Specify" (p. 17).
3. Press the "WRITE" Function button to save your preset.  
The display shows a confirmation message.

## Restoring the Factory Settings (Factory Reset)

The following function allows you to recall the VIVO SX8's original factory settings.

### WARNING

All data will be deleted. Backup your own settings to an USB memory. See "How to Protect Your Settings, Contents and Sounds List (Backup)" (p. 31).

1. Press [MENU/EXIT] button and select FACTORY RESET function using the [▲], [▼] and [▶] buttons. See "Moving the cursor and setting parameter values" (p. 17).  
The display shows the following window.



2. Press the "YES" Function button proceed.  
The message "Complete" informs you that the VIVO SX8 has been initialized.

## Restore the Factory Sounds

Using this function you can restore all sound libraries as they came out of the factory.

1. Press [MENU/EXIT] button and select FACTORY SOUND function using the [▲], [▼] and [▶] buttons.  
The following page appears:



**2. Press the "YES" Function button proceed.**

The message "Complete" informs you that the VIVO SX8 Sound Libraries has been restored.

If you no longer want to restore the sound libraries, press the "NO" Function button.

## How to Protect Your Settings, Contents and Sounds List (Backup)

You can back up contents, settings, and sounds list from your VIVO SX8 into a USB Memory.

This function is also useful before sending your instrument for repair.

**1. Press [MENU/EXIT] button and select the BACKUP function. See "Moving the cursor and setting parameter values" (p. 17).**

The following page appears:



## Backup Your Settings, Contents and Sounds List

**1. Connect the USB Memory to which you wish to save your data. See "Connecting an USB Memory (commercially available)" (p. 13).**

**2. Select the "EXPORT BACKUP" function. See "Moving the cursor and setting parameter values" (p. 17).**

The following page appears:



**3. If you want to name your backup, see "Assigning the Name You Specify" (p. 17) for details.**

**4. Press the "OK" Function button to perform the function.**

The following data are saved:

Backup Data
Global Parameters
Master Eq User Parameters
Memory Parameters
Memory Set Parameters
MIDI Set User Parameters
Temperament User Scale Parameters

Backup Data
Sound Library List

## Restore Your Settings, Contents and Sounds List

**1. Connect the USB Memory that contains the data. See "Connecting an USB Memory (commercially available)" (p. 13).**

**2. Select the "IMPORT BACKUP" function. See "Moving the cursor and setting parameter values" (p. 17).**

The contents of the USB memory are displayed:



**3. Use the [▲][▼] to select the backup data you want.**

**4. Press the "IMPORT" Function button to perform the function.**

The following page appears:

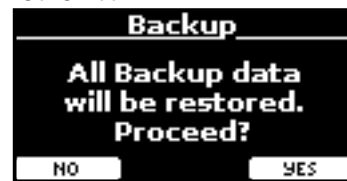

**5. Press the "YES" function button to proceed. All data will be restored.**

## Panic Function

Use this function if some operation on your instrument or an external tone generator (connected via a MIDI or USB cable) has caused strange sounds or stuck some notes..

**1. Press [MENU/EXIT] button and use the [▲][▼] to select the PANIC function.**



**2. Press the [▶] button to perform the function.**

"All notes off" and "Reset All Controllers" messages are sent to your VIVO SX8 sound generator and on all MIDI channels of an possibility connected sound generator.

# 14 Additional Sound (Sound Library)

## What is a Sound Library?

The sound (patch) in the DEXIBELL's devices is composed of several oscillators that reproduce waveforms. The patch contains also information about Pitch, TVA, TVF envelope, filters and so on. All this and more contributes to shapes the sound.

A **Sound library** contains sounds that use the same waveforms. For example, the "Electric Piano" library, contains the following sounds: Dyno Stage, Suitcase, Phaser EP, etc.

## Sound Library Memory Structure

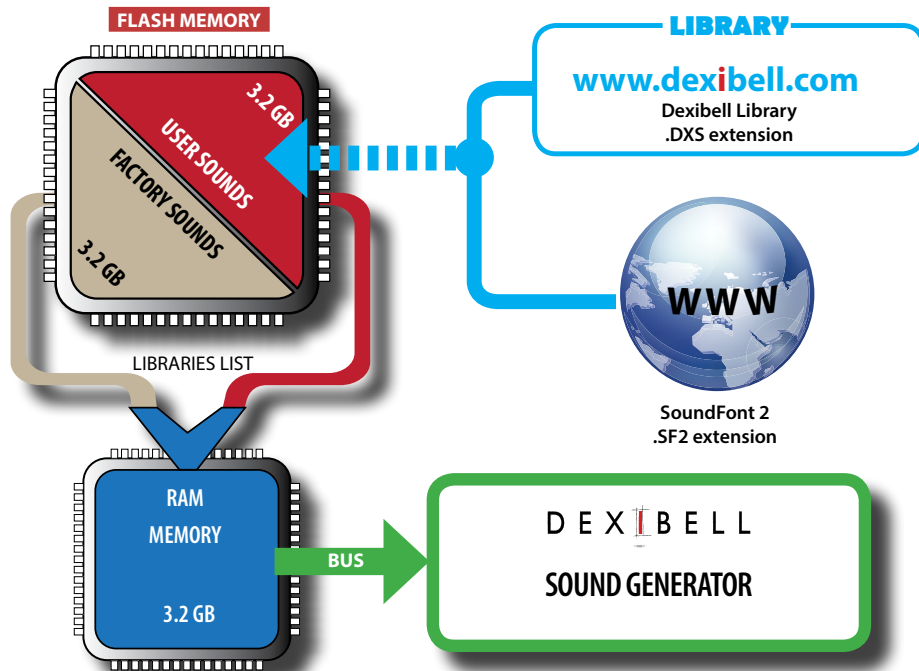

The VIVO SX8's Internal Flash Memory contains the Sound Libraries. This memory is divided into two parts of 3.2 GB:

- the first part, not erasable, contains the Factory Libraries.
- the second part, programmable, can contain the User Sound Libraries.

Using the list of libraries to load, at the power on, the VIVO SX8 load the sound libraries from the Internal Flash Memory into the Internal RAM of 3.2 GB. At default, the list contains the Factory Libraries only.

You can load the new libraries into the User Sound area by taking them from the DEXIBELL library ([www.dexibell.com](http://www.dexibell.com)) or from third-party sounds (.SF2 extension). By a programmable list you can choose which sound libraries (User or Factory or part of them) to load in the RAM Internal Memory. You can decide to completely replace the factory sounds loading all sound from the User sounds area or decide to load a part of the sounds from the factory area and another from the User area.

## Sound Library

VIVO SX8 gives you the possibility to install new sounds from:

- DEXIBELL Official Sounds (.DXS extension)  
These sounds will be available and downloadable from the following website:  
<http://www.dexibell.com/>  
*Stay tuned for new sounds and updates by visiting our website regularly!*
- third-party sounds (.SF2 extension)  
You can easy found in the web many sounds library with .SF2 extension. VIVO SX8 is compatible with these types of sounds.

Factory area ("INTERNAL ARCHIVE") ready to be reloaded again. See "Recovery a Library from the "INTERNAL ARCHIVE"" (p. 34) and "Restore the Factory Sounds" (p. 30).

1. Press [MENU/EXIT] button and select SOUND LIBRARY function pressing the [▶] button. See "Moving the cursor and setting parameter values" (p. 17).

A page like this appears:



The list of the Sound Libraries in the internal Memory are showed. You can note, at the left of each library name, a icons:

Icon	Explanation
	The library sound comes from the Factory Sound libraries.

## Remove and Add Sound Libraries

In the "SOUND LIBRARY" page you can decide which libraries load into the RAM area.

### NOTE

The removed libraries are not deleted. They remain in the



Icon	Explanation
	The library sound comes from the User Sound libraries.

At the bottom of the screen you can recall two functions: "REMOVE" and "ADD". Here below, we will explain how to remove or add sound libraries.

### Removing a Sound Library



1. Use the [DATA ENTRY] knob or the [▲] [▼] buttons to select the sound library you want to temporary remove.
2. If you want to know the sounds contained in the library, press the [▶] button to open it.



3. If you want to listen the sounds of the library, use the [DATA ENTRY] knob or the [▲] [▼] buttons to select the sound and activate notes via an external keyboard or computer connected to the VIVO SX8.

If you don't need of these sounds, you can proceed with the removal.

4. From the "SOUND LIBRARY" page, press the "REMOVE" Function button to perform the removal.

The display shows:



5. Press the "YES" Function button to perform the removal. Press "NO" if you no longer want to perform the function.

#### NOTE ABOUT THE REMOVAL OF SOUND LIBRARIES

- **Factory libraries** - The factory libraries are not deleted but are removed from the list of libraries to load at startup.
- **User Sound libraries** . The User Sound libraries are permanently deleted. Make sure to have a backup, if you think you need them again.

## How To Load Sound Libraries From a USB Memory

You can import sounds library in the User Sound memory of VIVO SX8 and use them in your performances. To import them you need an USB Memory and your Personal computer.

### Loading a sounds library in a USB Memory

1. Using your computer, download the new sound library from the DEXIBELL web site (.DXS) or from any other web site (.SF2).
2. Create a folder "SOUND" in the root of the USB Memory.
3. Copy the sound library (.DXS/.SF2) into the USB Memory's "SOUND" folder.
4. Insert the USB Memory into the VIVO SX8 USB port. See "Connecting an USB Memory (commercially available)" (p. 21).
5. See "Adding a Library from USB Memory" (p. 33) to import the sound library.

### Adding a Library



1. Press the "ADD" Function button to add a library.

The display shows the libraries previous removed:



In the example above, the list of removed libraries is empty (no libraries has been previously deleted). In this case you can add only libraries from an USB Memory previously loaded.

The following example shows that some libraries was removed and the list of "INTERNAL ARCHIVE" shows which they are:



2. If you want get information about the RAM Internal free memory, press the "FREE SIZE" Function button.



The page shows the RAM Internal memory available express in MB and percent.

This function is useful to know how much available free memory you have to load new libraries.

### Adding a Library from USB Memory

1. To load the library into your USB Memory, please refer to "Loading a sounds library in a USB Memory" (p. 33).

2. Insert the USB Memory into the USB port of the VIVO SX8.
3. From the "INTERNAL ARCHIVE" page, press the "USB" Function button to list the sound libraries in the USB Memory.

The following page is showed:



The instrument shows the sound libraries contained in the USB Memory's "/SOUND" folder.

**MEMO**

To navigate inside the folders use the [▶] button to open a folder and the [◀] button to return to a higher level .

Press the "INTERNAL" Function button to return to viewing the internal archive.

4. Use the [DATA ENTRY] knob or the [▲] [▼] buttons to select the sound library you prefer.
5. To open the sound library, press the [▶] button.

The sound/sounds contained in the library are displayed.



6. Use the [DATA ENTRY] knob or the [▲] [▼] buttons to select the sounds and listen them by the keyboard.

If the sounds are to your liking, you can import the library into the internal memory.

7. if you want to know the size of the library, press the "INFO" Function button.



8. Press the "IMPORT ALL" Function button to import the sound library.

The instrument asks you in which sound family you want to import the library:



9. Use the [▶] [◀] buttons to select in which sound family you want to import the library.

10. Press the "EXECUTE" Function button to perform the function.

A confirmation message informs you that the sound library has been imported.

## Recovery a Library from the "INTERNAL ARCHIVE"

Thanks to this function you can reload previously removed internal libraries.



1. Use the [DATA ENTRY] knob or the [▲] [▼] buttons to select the library you want reload into internal memory.

2. To open the sound library, press the [▶] button.

The sound/sounds contained in the library are displayed.



3. Use the [DATA ENTRY] knob or the [▲] [▼] buttons to select the sounds and listen them by the keyboard.

If the sound is to your liking, you can import the library into the internal memory.

4. if you want to know the size of the library, press the "INFO" Function button.



5. Press the "IMPORT ALL" Function button to import the sound library.

The instrument asks you in which sound family you want to import the library:



6. Use the [▶] [◀] buttons to select in which sound family you want to import the library.

7. Press the "EXECUTE" Function button to perform the function.

A confirmation message informs you that the sound library has been imported.

**How to Restore the Factory Sound**

See "Remove and Add Sound Libraries" (p. 32).

## How to Select USER Sounds

The VIVO SX8 has two memory areas concerning user sounds:

- The first area, divided into USER1 and USER2, relates to the TW (tonewheel) organs. Each area (USER1/USER2) contains 5 dedicated preset of ToneWheel. These areas can be selected via T2L function. See "How to Select USER Organ Sounds" (p. 35).
- The second area is related to orchestral sounds. It can be selected via the [USER] button from the sound selection panel. See "How to Select USER Orchestral Sounds" (p. 35).

## How to Select USER Organ Sounds

Before to select an USER sound, you need to import sounds. Please see "How To Load Sound Libraries From a USB Memory" (p. 33).

1. Select a preset organ sound. See "Selecting Presetted Organ Sounds" (p. 22).

The display shows a page like this:



The organ tone is shown as follows:

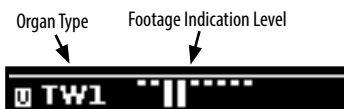

2. Press the "T2L EDIT" function button and using the [▲] [▼] buttons, select "ORGAN TYPE".

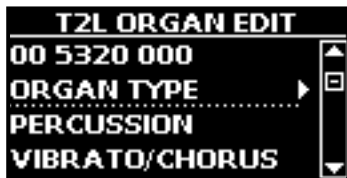

3. Press the [▶] button to access the ORGAN TYPE page.

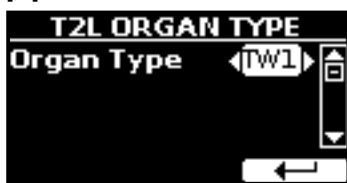

4. Use the [DATA ENTRY] knob or the [◀] [▶] buttons to select the USER1 or USER 2 type organ.

The USER1 or USER2 area is now selected.

To select another ToneWheel within the previously selected User area:

5. Press the [SOUND] button.

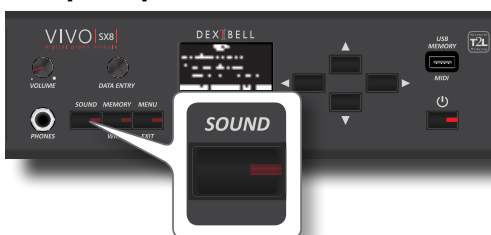

The [SOUND] indicator lights and a temporary page shows the list of the

sounds of the selected part, the current sound is underlined:



6. While the tone window is active, use the [▲] [▼] buttons to select a different organ preset.

The ToneWheel is recalled and the window highlight you the footage indication of the sound. After few seconds of inactivity of the change sound operation, the Main page is shown.

### TIPS

A quick way to change a tone from the Main page: use the [DATA ENTRY] knob or the [◀] [▶] buttons to select a next or previous sound in the same category.

## How to Select USER Orchestral Sounds

Before to select a USER sound, you need to import sounds. Please see "How To Load Sound Libraries From a USB Memory" (p. 33).

1. Press the [SOUND] button.



The [SOUND] indicator lights and a temporary page shows the list of the sounds of the selected part, the current sound is underlined:



2. While the page is active, press the [◀] [▶] buttons to select the USER sound family.

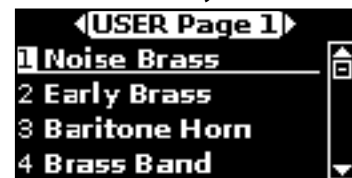

3. While the page is active, use the [DATA ENTRY] knob or the [▲] [▼] buttons to select a tone in the USER page. If during normal operation the window closes automatically, press the [SOUND] button again.

### TIPS

A quick way to change a tone from the Main page: use the [DATA ENTRY] knob or the [◀] [▶] buttons to select a next or previous tone.

# 15 Sound Setup (Export/Import)

This is a useful function that allows you to prepare a sound set for a performance. If, in a performance, you will use only piano sounds, you can create a Sound Set that contain only piano sounds. In this way you can use the maximum size of internal memory of the instrument for piano sounds. At your convenience, you can also download sound sets from the <http://www.dexibell.com/> website.

## Exporting a Sound Set ("EXPORT SETUP")

This function export the sound set, that you have previously prepared, in a USB Memory.

1. Prepare your Sound Set using the functions previously explained: "ADD" and "REMOVE". See "Remove and Add Sound Libraries" (p. 32).
2. Insert a USB Memory into the USB port of your instrument.
3. Press the [MENU/EXIT] button and use the [DATA ENTRY] knob or the [▲][▼] buttons to select the "SOUND SETUP" function group.



The "SOUND SET" page appears:



4. Use the [DATA ENTRY] knob or the [▲][▼] buttons to select "EXPORT SETUP" and press the [▶] button to access the function.

The display changes to:



5. If you want to name your Sound Set, please see "Assigning the Name You Specify" (p. 17).
6. Press the "OK" Function button to save your Set.  
A confirmation message is temporarily showed.

## Importing a Sound Set ("IMPORT SETUP")

This function import the sound set previously saved in a USB Memory.

### NOTE

Before to import a Sound Set take in consideration that your current Sound Set, in the internal memory, will be replace. You can lost external sound libraries previously loaded from a USB Memory. Regarding the internal sound libraries no problem, You can recover them in the "INTERNAL ARCHIVE". See "Adding a Library" (p. 33).

1. Insert a USB Memory that contains previously saved Sound Set into the USB port of your instrument.
2. Press the [MENU/EXIT] button and use the [DATA ENTRY] knob or the [▲][▼] buttons to select the "SOUND SETUP" function group.



The "SOUND SET" page appears:



3. Use the [DATA ENTRY] knob or the [▲][▼] buttons to select "IMPORT SETUP" and press the [▶] button to access the function.

The display shows the list of the Sound Set in the USB Memory:



4. Use the [DATA ENTRY] knob or the [▲][▼] buttons to select the Sound Set.
5. Press the "IMPORT" Function button to load the Sound Set.  
A confirmation message is temporarily showed.

# 16 Personalizing Your Sounds

## T2L-Modelling



The revolutionary technology found on all models of DEXIBELL digital Pianos.

T2L-Modelling is the combination of innovative technologies developed to achieve maximum timbre accuracy and precise sound responsiveness to the multiple articulations of a pianist.

T2L modelling has many algorithms that simulate all the characteristics of an acoustic piano. It take care of many aspect as:

### No Damper ("No Damper" on high notes)

The last 18 higher notes, like in the acoustic instrument, do not have the presence of the dampers and then are free to vibrate even when keys are released.

The duration of these notes, playing in staccato mode, is much longer than the previous notes that instead have the presence of the damper.

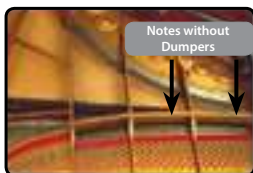

### FP-Simulation ("DAMPER Pedal" multi actions simulation)

The "DAMPER" Pedal (Sustain), performs several actions that are simulated through this function.

A) When the "DAMPER" pedal is pressed, a sound is generated to simulate the damper friction noises of felts when releasing from the strings (Damper Friction Noise).

B) Pressing the "DAMPER" pedal, the active notes will be enriched with resonances produced by all strings free to vibrate, thanks to the raised dampers (Strings Resonance). The result of the Strings Resonance makes the sound of a sustained note by the use of the "DAMPER" pedal substantially different from the sound of a just held note.

C) When the "DAMPER" pedal is released, a noise is simulated like the mechanical noise in the acoustic instrument (Sustain Pedal Mechanical Noise).



(A) & (B) "DAMPER" pedal is pressed, felt dampers are raised.



(C) "DAMPER" pedal is released, felt dampers are resting on strings.

See "DAMPER PEDAL" (p. 53).

### SP-Simulation ("Soft Pedal" Simulation)

The "Soft" Pedal, acts a change of volume and timbre color of the sound, simulating the "soft" function on the acoustic piano.



Soft Pedal

You can change many sound parameters at will.

## Making Slight Additions or Sound Alterations

Although Dexibell sound are developed to achieve the maximum sound accuracy, you can necessity to modify them at your taste them or create new sonority.

Take note that the parameters of the sound you want modify are of the part (1, 2, 3). This means that the same sound modified for the part 1 will sound different if selected from the part 2.

1. From the Main page use the [▲] [▼] buttons to select the part you want modify the sound.
2. Select the sound that you want to edit. See "Selecting the Tones" (p. 20) and "Organ Section" (p. 22).
3. From the main page, press the [T2L] function button to access the T2L editor functions.



Depending on the type of sound selected (orchestral or organ), the following page is displayed:



4. Use the [▲] [▼] buttons to select the parameter you wish to modify.
5. Use the [DATA ENTRY] knob or the [◀] [▶] buttons to adjust the value.

## Saving your changing

All you need to do is to save your setting in a memory. See "Working with the Memories" (p. 42).

## Parameters to be edited

The parameter list depends on the characteristics of the selected sound.

## Orchestral Sounds Parameters

VIVO SX8 allows you to personalize the tones by adjusting various factors that affect the sound.

Each Tone has available a number of parameters that allow you to personalize the sound. Below, you'll find an example of some parameters characterizing the piano sound.

### Hammer-Noises (Key On impulsive Noises)



Attack of notes contains an impulsive portion of sound produced by the hit of the Hammer to the strings, amplified and sustained by the resonance of the piano body. A function is available to reduce/increment this element of the sounds.

Parameter	Setting
Hammer Noise	-64 ~ 0 ~ +63

### Key Off Noise (Key Off Mechanical Noises)

The release of keys causes mechanical noises proportional to the speed of the release itself. This behavior of the acoustic instrument is reproduced by this function.

Parameter	Setting
Key Off Noise	-64 ~ 0 ~ +63

### Damper Noise

This is the typical noise of an acoustic piano when the pedal sustain is pressed (lift all dampers) or released (lower all dampers).



Dampers

Parameter	Setting
Damper Noise	-64 ~ 0 ~ +63

### String Reso (Sympathetic Harmonic Resonances)

As in the acoustic Piano, while holding down some keys and playing other notes in staccato mode, a multitude of additional harmonics can be listened, thanks to "sympathetic resonance" generated by the free to vibrate strings (due to raised dampers) of the held notes.

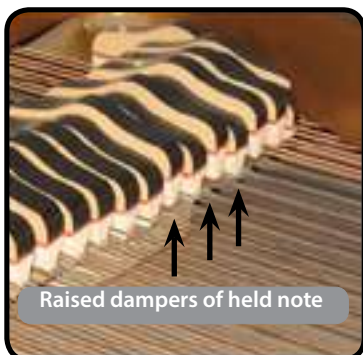

Raised dampers of held note

Parameter	Setting
String Reso	-64 ~ 0 ~ +63

### Damper Reso

It's the typical noise generated by the free to vibrate strings (all damper raised) when the damper pedal is pressed.

Parameter	Setting
Damper Reso	-64 ~ 0 ~ +63

### Cabinet Reso (Wurlly, Ac. Guitar, Harp)

Thanks to this parameter you can increase or decrease the cabinet resonance.

Parameter	Setting
Cabinet Reso	-64 ~ 0 ~ +63

### Bell (for Electric Piano)

The "bell sound" is characteristic of some electric pianos that became particularly popular throughout the 1970s.

You can adjust the quantity of this typical sound.

Parameter	Setting
Bell	-64 ~ 0 ~ +63

### Growl (for Electric Piano)

This is a typical distortion of the sound during the phase attack that give a "growling" effect. Thank to this parameter you can increase or decrease the effect.

Parameter	Setting
Growl	-64 ~ 0 ~ +63

### Off Noise (for Clavinet, Harpsi, E. Piano, Bass)

You can adjust the quantity of the noise effect that some instrument produce when the key is released.

Parameter	Setting
Off Noise	-64 ~ 0 ~ +63

### On Noise (for Trumpet, Flugelhorn)

This parameter adjust the quantity of the noise of the trumpet when the piston is pressed.

Parameter	Setting
On Noise	-64 ~ 0 ~ +63

### Attack, Hold, Decay, Sustain and Release (For Brass, Strings, Pad, Choir, Synth, Jazz Guitar)

These parameters characterize the envelope of the sound. For example, when an organ key is pressed, it plays a note at constant volume; the sound dies quickly when the key is released. By contrast, the sound of a guitar is loudest immediately after a string is plucked, and quickly fades. Try to change the envelope of a sound by these parameters.

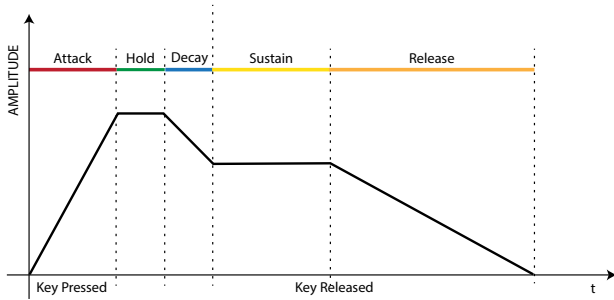

Parameter	Setting
Attack	
Hold	
Decay	
Sustain	-64 ~ 0 ~ +63
Release	
Cutoff	
Resonance	

The envelope (Attak, Hold, Decay, Sustain and Release) aren't limited to controlling just volume (amplitude) but, in some instruments as Strings, Pad, Choir and Synth, it controls some filter parameters such as Cutoff and Resonace. You can determine the frequency at which the filter starts working (Cutoff) and how much it "boosts" the frequencies around the cutoff frequency.

### Ride

This parameter increase or decrease the volume of Ride Cymbals sound contained in the "Ac. Bass&Ride" tone.

Parameter	Setting
Ride	-64 ~ 0 ~ +63

### Amp noise

This parameter simulates the noise of the bass amplifier.

Parameter	Setting
Amp noise	-64 ~ 0 ~ +63

### String noise

This parameter simulates the resonance of the bass strings.

Parameter	Setting
String noise	-64 ~ 0 ~ +63

### Key Noise

This parameter simulates the noise of Saxophone Key.

Parameter	Setting
Key noise	-64 ~ 0 ~ +63

### Polyphonic

This parameter becomes useful when you use some solo instruments like flute, violin, saxophone, trumpet and accordion.

Parameter	Setting	Explanation
Polyphonic	Low, High, Last, Poly	<p><b>Low</b> - The part becomes monophonic and play the leftmost note you played.</p> <p><b>High</b> - The part becomes monophonic and play the rightmost note you played.</p> <p><b>Last</b> - The part plays monophonic.</p> <p><b>Poly</b> - The part plays polyphonic.</p>

### Blow

Blowing is possibly the most important part of any woodwind instrument. This parameter adjusts the amount of blowing in a flute sound.

Parameter	Setting
Blow	-64 ~ 0 ~ +63

### Pluck

This parameter is used to emphasize the sounds of "Pedal Bass" e "Pedal DoubleBs". It works to emphasize the attack phase of the sound.

Parameter	Setting
Pluck	-64 ~ 0 ~ +63

## Organ Sounds Parameters

Through these parameters it is possible to change the type of organ and many parameters associated with it.

### Organ Type

Use this parameter to change the organ type: TW1, TW2, FARF, VX and PIPE. For details see "Selecting Various Organ Types" (p. 22).

### Percussion

This effect was designed to emulate the percussive sounds of the harp, xylophone and marimba. It's the classic crisp attack unique to the vintage organ.

For details see "Adding Harmonic Percussion" (p. 23).

### Vibrato/Chorus

The vibrato and chorus system consists of six settings, V1, V2, V3, C1, C2 and C3 (i.e., 3 vibrato and 3 chorus).

For details see "Applying Vibrato/Chorus Effect" (p. 24).

### Overdrive

This is the typical effect of vacuum tube amplifier and it is achieved by "overdriving" the valves.

For details see "Adding Overdrive Effect" (p. 24).

### Organ Common

#### Volume

This parameter reduce the volume of the tonewheel. When you set the "Soft" value the volume of the tonewheel became slightly softer in volume and equalization.

Parameter	Setting
Volume	Normal, Soft

## Leakage

In the vintage electro-mechanical organs, sometimes the signal from adjacent tonewheels causes pickups to overhear tonewheels other than their own. This noise, originally considered to be a defect, grew to be an integral part of the electro-mechanical organ sound. Use this parameter to modify the amount of leakage.

Parameter	Setting
Leakage	0 ~ 127

## Hum noise

The sound of the organ is produced by an electro-magnetic pick-up. So some hum is normal and unavoidable in an electro-mechanical organ. If you think you suffer from excessive hum, you can modify the level.

Parameter	Setting
Hum noise	0 ~ 127

## Click On Noise and Click Off Noise

Some electro-mechanical organs have an audible pop or click when a key is pressed or released. Originally, key click was considered a design defect and the designers worked to eliminate or at least reduce it with equalization filters. Over time has become a characteristic part of the sound and it has been accepted as part of the classic sound. Use this parameter to adjust the amount of click noise.

Parameter	Setting
Click On Noise	0 ~ 127
Click Off Noise	

## Perc. Manual

It's the classic crisp attack unique to the vintage organ. See "Adding Harmonic Percussion" (p. 23). The percussion is a typical register in the Main manual. With this parameter, you can choose which part of the keyboard (MAIN or LOWER) to add the percussion effect.

Parameter	Setting
Perc. Manual	Main, Lower

## Expression Min

The expression pedal is an important control for many musical instruments including organs. Use this parameter to set the minimum value of the expression when the pedal is lifted.

Parameter	Setting
Expression Min	0 ~ 127

## Express. Tone

When the volume falls, the sound of the high or low frequencies becomes difficult to hear. When this parameter is set to "On", when the volume falls, the low frequency are less attenuated than Mid/high frequencies.

Parameter	Setting
Express. Tone	Off, On

## Brilliance

This parameter is enabled when you select a Pipe organ type. You can adjust the brightness of sound.

Parameter	Setting
Brilliance	-12 ~ +12

## Rotary

Rotary Block Diagram

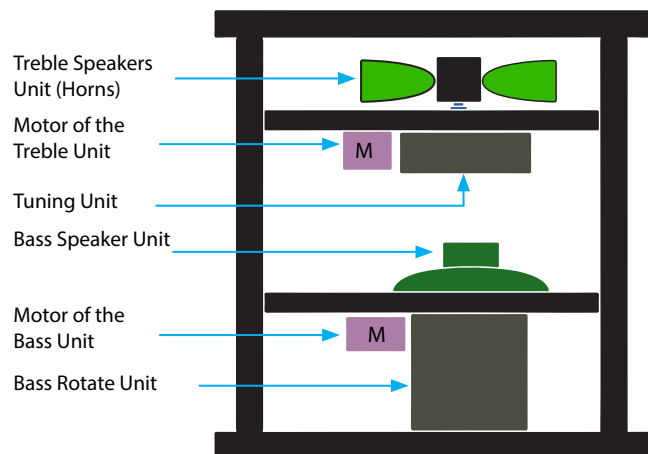

## Rotary Type

This parameter determines the mode of rotation.

Parameter	Setting	Explanation
Rotary Type	A, B	<p><b>A:</b> Normal simulation.</p> <p><b>B:</b> Advanced simulation. Already introduced on J7 and S9 with previous OS 4.06, this effect is our latest generation of Rotary Speaker effect conceived with a new algorithm that makes the entire depth and the simulation of the horn and bass speakers rotations even more truthful. Accelerations and decelerations are so accurate that you have the perception to virtually see the moving speakers adding this essential character to your organ performances.</p>

## Rotary Noise

This is the noise when the motor is running. Use this parameter to adjust the amount of the noise.

Parameter	Setting
Rotary Noise	0 ~ 127

## Horn Slow RPM and Horn Fast RPM

These parameters adjust the speed of the horn rotor at the slow and fast mode.

Parameter	Setting
Horn Slow RPM	20 ~ 100
Horn Fast RPM	300 ~ 500

## Horn RampUp and Horn RampDw

These parameters set the time for the horn rotors to "ramp up" and to "ramp down" when switching from slow to fast (Horn RampUp) or when switching from fast to slow (Horn RampDw).



## Adjusting the Keyboard Velocity Response According to the Sound

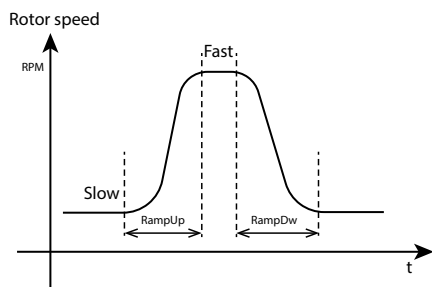

Parameter	Setting
Horn RampUp	0.2 ~ 15 sec.
Horn Ramp Down	

### Bass Slow RPM and Bass Fast RPM

These parameters adjust the speed of the bass rotor at the slow and fast mode.

Parameter	Setting
Bass Slow RPM	20 ~ 100
Bass Fast RPM	300 ~ 500

### Bass RampUp and Bass RampDw

These parameters set the time for the bass rotors to "ramp up" and to "ramp down" when switching from slow to fast (Bass RampUp) or when switching from fast to slow (Bass RampDw).

Parameter	Setting
Bass RampUp	0.2 ~ 15 sec.
Bass RampDw	

- Use the [▲] [▼] buttons to select one of the three parameters available.
- Use the [◀] [▶] buttons to adjust the parameter you selected.

Parameter	Setting	Explanation
Start	0~127	It is the starting point of the velocity curve where you want to operate with the compression or expansion.
Rate	0.1~8.0	It is the compression/expansion coefficient that you want to use.
Offset	0~127	It's the minimum value of velocity.

In the example below you can see that the Start point was set to 52, the "Offset" starts from the value 35 and the rate was set to 2.7.

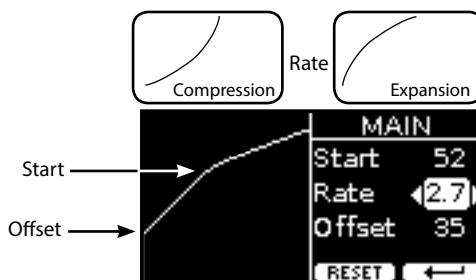

- Press the "RESET" Function button to restore the parameters at the default value.

## Adjusting the Keyboard Velocity Response According to the Sound

By the "Velocity Comand" function in the T2L MENU, you can adjust the keyboard velocity for each sound. You can choose to expand the velocity of a Piano sound and compress the velocity of a strings or Pad sound.

- Please refer to the "Making Slight Additions or Sound Alterations" (p. 37) to access the "T2L EDITOR" functions.
- In the example below we selected the sound of the part 3. Use the [DATA ENTRY] knob or the [▲] [▼] buttons to move the cursor under the "Velocity Comand" function.



- Press the button [▶] to access the function.

The following page appears:



# 17 Working with the Memories

Using the Memories is a lot faster than calling up one of the VIVO SX8's functions, modifying the settings, etc., while you're playing. Just one touch and you recall your panel setting for that performance.

VIVO SX8 provides 80 memories already preset by the factory with many useful settings. You can overwrite them according to your needs.

## About the Memories and Memory Set structure.

The Memories you create are saved in the internal Memory Set or in an external Memory Set previously saved in the USB Memory. This allows you to prepare one set of Memories for weddings, another for corporate events, a third for anniversaries, etc.

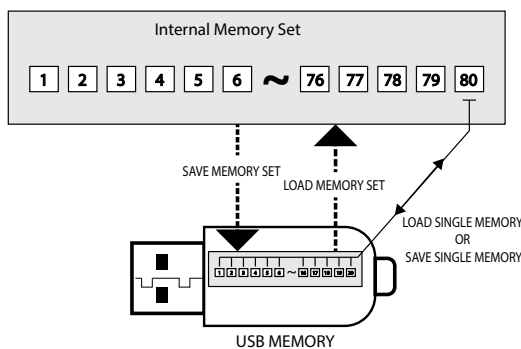

5. If you want to name your new Memory, see "Assigning the Name You Specify" (p. 17) for details.

6. Press the "OK" Function button to save the Memory.

The memory will be saved and the list of Internal Memory is shown.



## Recalling your Settings from Internal Memory

1. Press the [MEMORY/WRITE] button.

The [MEMORY/WRITE] button indicator lights steady and the list of Internal Memory is shown.



### MEMO

You can also select this function pressing [MENU] button →MEMORY→RECALL.

2. Use the [DATA ENTRY] knob or the [▲][▼] buttons to move the cursor inside the list to select the memory you want to recall.

3. Press the "RECALL" Function button to recall the Memory.

The Memory is recalled and the display shows the Memory highlighted.



## Saving Your Settings in the Internal Memory

1. Change all settings the way you want to save them.

For details about the settings memorized, see p. 51.

2. Press and hold the [MEMORY/WRITE] button until the display shows:



The [MEMORY/WRITE] button indicator flashes and the list of Internal Memory is shown.

### MEMO

You can also select this function pressing [MENU] button →MEMORY→WRITE.

3. Use the [DATA ENTRY] knob or the [▲][▼] buttons to move the cursor inside the list in the position you want to replace the memory.

4. Press the "SAVE" Function button to confirm.

The display changes to:



## How to Rearrange the Order of Memories

Use this function if you need to rearrange your Memories in a different order.

4. Press the [MENU/EXIT] button and select MEMORY→REORDER.



The display shows a list of Memories.



- Use the [▲][▼] buttons to move the cursor inside the list to select the Memory you want to reorder and press the "MOVE" function button.

An  symbol appears to the left of the selected Memory.



- Use the [▲][▼] buttons to select the new position where you want to move the selected Memory.



- Press the "OK" Function button to confirm the operation.  
Press "CANCEL" Function button to cancel the operation

## Saving Your Settings in the USB Memory (commercially available)

- Connect the USB Memory to which you wish to save the Memory. See "Connecting an USB Memory (commercially available)" (p. 13).
- Change all settings the way you want to save them.
- Press and hold the [MEMORY/WRITE] button until the display shows:



The list of Internal Memory is shown.

### MEMO

You can also select this function pressing [MENU] button  
→MEMORY→WRITE.

- Press the [USB] Function button to select the destination memory.

The display shows a list of all files and folders on the USB storage device you have just connected.



Now you can save:

- In a Memory Set previously saved. Continue from step (5)
- In a new Memory Set. See "Saving in the New Memory Set" below.

## Saving in the Memory Set previously saved

- Use the [▲][▼] buttons to scroll through files and folders to select the Memory Set.

Memory Set Icon	Memory Set file extension
	.rif

Use the "OPEN" Function button if you need to enter in a folder.  
If you opened a folder by mistake, press the [+ ] button to return to a higher level.

- Press the "OPEN" Function button to recall the Memory Set.

The display shows the list of memories in the Memory Set.



- Use the [▲][▼] buttons to move the cursor inside the list in the position you want to replace the Memory.

- Press the "SAVE" Function button to confirm.

The display changes to:



- If you want to name your new Memory, see "Assigning the Name You Specify" (p. 17) for details.

- Press the "OK" Function button to save the Memory.

The memory will be saved and the list of memories is shown.



## Saving in the New Memory Set

1. Press the "NEW SET" Function button to create an empty Memory Set.

This page allows you to create a new Memory Set List whose name is selected automatically by the VIVO SX8.



2. If you want to name your new Memory Set, see "Assigning the Name You Specify" (p. 17) for details.
3. Press the "OK" Function button to confirm the name. The display shows contents of the new Set just created.



4. Use the [▲][▼] buttons to move the cursor inside the list in the position you want to write the Memory.
5. Press the "SAVE" Function to confirm. The display changes to:



A Memory name is suggested by the VIVO SX8.

6. If you want to name your new Memory, see "Assigning the Name You Specify" (p. 17) for details.
7. Press the "OK" Function button to save the Memory. The memory will be saved and the list of Memories is shown.



## Recalling your settings from an USB Memory

1. Connect an USB memory to the VIVO SX8. For details see p. 13.  
A USB icon appears in the Icons field of Main page. See "Main Page" (p. 16).
2. Press the [MEMORY/WRITE] button.  
The [MEMORY/WRITE] button indicator lights steady and the list of Internal Memory is shown.



### MEMO

You can also select this function pressing [MENU] button →MEMORY→RECALL.

3. Press the "USB" Function button.

The display shows a list of all files and folders on the USB storage device you have just connected.



4. Use the [▲][▼] buttons to scroll through files and folders to select the Memory Set.

Memory Set Icon	Memory Set file extension
	.rif

Use the "OPEN" Function Button to enter in a folder. If you opened a folder by mistake, press the [←] button to return to a higher level.

5. Press the "OPEN" Function button to open the selected Memory Set.

The display shows the list of Memories:



6. Use the [▲][▼] buttons to move the cursor inside the list to select the Memory you want to recall.

7. Press the "RECALL" Function button to recall the Memory. The Memory is recalled and the display shows the Memory highlighted.



### MEMO

To display the Internal Memories again, press the "INTERNAL" Function button.

## Renaming a Memory

This function allows you to change the name of a selected Memory.

1. Press the [MENU] button and select MEMORY→RENAME.

The list of Internal Memory is shown:



2. Use the [▲][▼] buttons to move the cursor inside the list in the position you want to rename the Memory.

3. Press the "RENAME" Function button to confirm.

The display changes to:



4. Use the [▲][▼] and the [◀][▶] buttons to rename the Memory. See "Assigning the Name You Specify" (p. 17) for details.

5. Press the "OK" Function button to confirm the name.

The memory will be renamed and the list of Internal Memory is shown.



## Exporting a Memory Set in the USB Memory

Use this function for exporting the Internal Memory Set in the USB Memory (commercially available).

This function is useful to create special sets for each event and import them at your convenience.

You can also use this function to backup the Internal Memories.

1. Connect an USB memory to the VIVO SX8. For details see p. 13.

A USB icon appears in the Icons field of Main page. See "Main Page" (p. 16).

2. Press the [MENU] button and select MEMORY→EXPORT SET.



The display shows a list of all files and folders on the USB storage device you have just connected.



3. Use the [▲][▼] buttons to scroll through folders to select the destination folder.

Use the "OPEN" Function button to enter in a folder.

If you opened a folder by mistake, press the [↶] button to return to a higher level.

4. Press the "EXPORT" Function button to confirm your selection.

The display changes to:



A Memory Set name is suggested by the VIVO SX8.

5. If you want to name the Memory Set, see "Assigning the Name You Specify" (p. 17) for details.

6. Press the "OK" Function button to export the Memory Set.

A message confirm the operation.

### NOTE

You should always safely eject the USB Memory before physically unplugging it from USB socket. Before to unplug the USB Memory use the "USB REMOVE" function. See "Safely Remove the USB Memory" (p. 14).

## Importing a Memory Set from the USB Memory

Use this function for importing Sets from the USB Memory (commercially available) to Internal Memory.

1. Connect an USB memory that contains Memory Sets to the VIVO SX8. For details see p. 13.

A USB icon appears in the Icons field of Main page. See "Main Page" (p. 16).

2. Press the [MENU] button and select MEMORY→IMPORT SET.

The display shows a list of all files and folders on the USB storage device you have just connected.



3. Use the [▲][▼] buttons to scroll through folders to select the Memory Set to import.



Use the "OPEN" Function button to enter in a folder.  
If you opened a folder by mistake, press the [↵] button to return to a higher level.

4. Press the "IMPORT" Function button to confirm your selection.

A message confirm that the Memory Set was imported.

**NOTE**

You should always safely eject the USB Memory before physically unplugging it from USB socket. Before to unplug the USB Memory use the "USB REMOVE" function. See "Safely Remove the USB Memory" (p. 14).

2. Press the [MENU] button and select MEMORY→SAVE AS DEFAULT.



The instrument asks you if you want your settings as default.



3. Press the "Yes" Function button to confirm the operation. Press "No" to quit the function.

## Deleting a Memory Set

Use this function to delete a Memory Set from an USB Memory.

5. Press the [MENU] button and select MEMORY→DELETE SET.



The display shows a list of all files and folders on the USB storage device you have just connected.



6. Use the [DATA ENTRY] or the [▲][▼] buttons to move the cursor inside the list in the position you want to delete the Memory Set.



7. Press the "DELETE" Function button to delete the selected Memory Set.

A message confirm the operation.

## How to Automatically Recall Your Favorite Setting at the Power On.

The VIVO SX8 give you the possibility to have your favorite setting directly at the startup of the instrument. To do this, follow the procedure below:

1. Set all the parameters you want when you turn on the instrument.

# 18 Playing with Audio Backing Tracks

Thanks to X MURE® application and VIVO SX8 you can play your favourite melodies while controlling a audio pattern.



X MURE® is a DEXIBELL® software product

## WHAT IS X MURE

- X-MURE is an application that runs on iPhone or iPad.
- Using "Harmony Poly Fragmentor" the world first algorithm able to modify "audio tracks" in real time, "X MURE" allows you to play music directly on the screen of your iPad/iPhone or with a musical instrument connected via USB.
- "X MURE" does not use sound generators, virtual instruments or "Standard MIDI file", it is exclusively based on audio tracks recorded by real musical instruments, so it does not simulates reality... it is the reality.

## WHAT YOU CAN DO WITH X MURE

- Control X MURE audio patterns by live chord progression played by a connected MIDI keyboard.
- Re-arrange your favourite music tracks using countless musical genres or create a completely new song hit.

## WHAT YOU NEED TO USE X MURE

- A connected MIDI keyboard
- Apple iPad Camera Connection Kit (Camera connectors made by Apple Inc.).
- USB cable (type A—male - type B—male: commercially available).
- Audio cable (3.5 mm jacks).
- Download X MURE application from App Store.



## Playing with X MURE Application

1. Turn your VIVO SX8 and your iPad on.
2. Touch the X MURE icon in your iPad to open the app.  
Now you have three possible choices:



3. Touch Dexibell VIVO icon to have the maximum performance with VIVO SX8.  
The following page appears:



4. Play a note in the keyboard to inform X MURE which part you want use to control it.
5. On X MURE select the audio pattern you want play back.
6. Touch the play icon of the X MURE application.  
The pattern start to play back.

### MEMO

You can use a pedal to Play or Stop the play back of the pattern. See "CONTROL" (p. 53).

7. Play chords in the keyboard. The audio pattern follows your chord progression.
8. On X MURE touch the "A", "B", "C", "D" icon button to chose a different scene.

### MEMO

You can use a pedal to select different scene. See "CONTROL" (p. 53).

9. On X MURE touch the "1", "2", "3", "4" icon button to chose a different drum pattern.

### MEMO

You can use a pedal to select different drum pattern. See "CONTROL" (p. 53).

## Connecting your Mobile Device

### Typical Connection



## Bluetooth® Audio and MIDI Connectivity

VIVO SX8 Pianos are equipped with Audio and MIDI Bluetooth® (4.2 Low Energy) function.

Thanks to this technology, you'll be able to :

- listen through the speakers of the VIVO SX8 the music played back by smartphone, tablet.
- exchange MIDI data between the mobile device and the VIVO SX8.



## Connecting with the Mobile Device

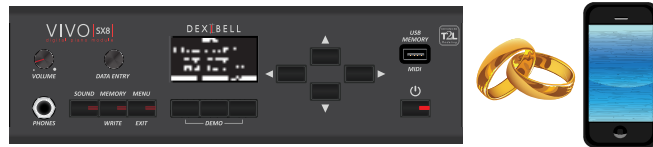

### NOTE

Please take in consideration that the explanation to pair your mobile device with the VIVO SX8 is as an example. The operations to pair your mobile device can be different from our explanation and depend on the operating system of your device. For details, please refer to the owner's manual of your mobile device.

1. Place the mobile device within 1 meter (3 ft) from VIVO SX8.

### NOTE

When pairing, make sure that other devices are off or out of range.

2. Make sure that VIVO SX8 is visible to other devices. See "Turning on the VIVO SX8's Bluetooth® Functions" (p. 48).
3. On the mobile device that you want to connect, turn on the Bluetooth® function and, if necessary, search for the available devices.

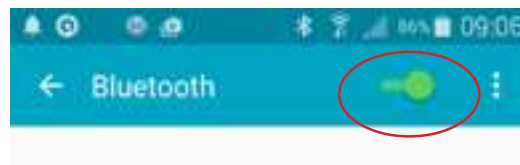

For details on how to enable the Bluetooth® function, refer to the owner's manual of your mobile device.

The list of available devices is now shown in your mobile device.

4. Select the "dexi-piano-xx" device that is shown in the Bluetooth® list of your mobile device.



In example above the device name is "dexi-piano-BF".

5. If the mobile device and the VIVO SX8 ask you to confirm the connection showing the "passkey" screen, confirm before on VIVO SX8 and then on your mobile device.



## Turning on the VIVO SX8's Bluetooth® Functions

1. press the [MENU] button and select Bluetooth® page.



2. Use the [▲][▼] buttons to select the "Visible" parameter.
3. Use the [◀][▶] buttons to set it "On".

The VIVO SX8 is now visible to other devices:



The first time you use a new mobile device, you need to "pair" it with your device so that both devices know how to connect securely to each other.



When pairing succeeds "dexi-piano-xx" is added to the list of paired devices in the mobile device. Viceversa the mobile device is added to the list of "Paired" devices of VIVO SX8.



6. Select the "dexi-piano-xx" device that is shown in the paired devices list of your mobile device.

**MEMO**

For details, refer to the owner's manual of your mobile device.

**MEMO**

Once the devices have been paired, there is no need to perform pairing again. Once the device is recognized, the VIVO SX8 ask you to authorize the connection:



Choose "YES" to authorize the connection. The following page appears:



The connection is now established and a Bluetooth® icon is shown in the main menu. The music data played back by the mobile device can be heard through VIVO SX8.

**NOTE**

Pairing is required again if you execute a Factory Reset (p. 30).

## Connecting an Already Paired Mobile Device

**NOTE**

Please take in consideration that the explanation to connect your mobile device with the VIVO SX8 is as an example. The operations to connect your mobile device can be different from our explanation and depend on the operating system of your device. For details, please refer to the owner's manual of your mobile device.

1. Place the mobile device within 1 meter (3 ft) from the VIVO SX8.
2. If necessary, turn on the Bluetooth® function on the mobile device.
3. Select the "Dexi-piano-xx" device that is shown in the Bluetooth® list of your mobile device.

**MEMO**

For details, refer to the owner's manual of your mobile device.

## Using Bluetooth® Audio

You can use the speakers of the VIVO SX8 to listen to music or music videos played on your mobile device.

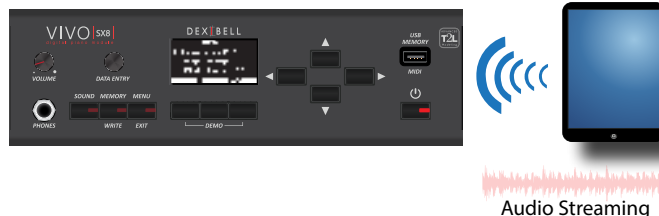

1. If necessary, turn on the Bluetooth® function of the VIVO SX8 and pair your mobile device. You don't need it if it's already paired.

See "Turning on the VIVO SX8's Bluetooth® Functions" (p. 48) and "Connecting with the Mobile Device" (p. 48).

2. Locate your mobile device near the VIVO SX8.

3. Turn on the Bluetooth® function of your mobile device.



All music data played back by the your mobile device can be now heard through VIVO SX8.

## Transferring Bluetooth® MIDI Data

Here's how to do for transmitting and receiving MIDI data between the VIVO SX8 and your mobile device.



In particular, we will take as an example the connection between the VIVO SX8 and the "Dexibell VIVO EDITOR" application.



**What is the "Dexibell VIVO EDITOR" application?**

It a free iOS application downloadable from **Apple Store**.

**What does the "Dexibell VIVO EDITOR" do?**

It allows you to modify any parameter of the VIVO SX8 in realtime. It is as if the device becomes the color display with touch screen of your instrument.

1. Turn on the "Visible" parameter of the VIVO SX8 in the bluetooth page and pair your mobile device.

See "Turning on the VIVO SX8's Bluetooth® Functions" (p. 48) and "Connecting with the Mobile Device" (p. 48).

2. Locate your mobile device near the VIVO SX8.

3. Turn on the Bluetooth® function of your mobile device.

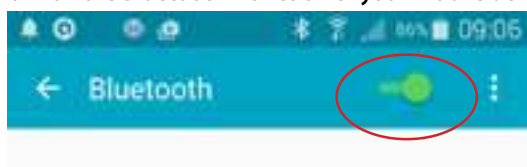

4. Start the "Dexibell VIVO EDITOR" and tap the "MEMORY" page.



5. Tap the "⚙️" icon.



6. In the Bluetooth MIDI field, Tap the "DEVICE" button.



The Bluetooth MIDI devices page is opens and the VIVO SX8 ( dexi-piano-xx) is in the list of found devices.

7. Tap "Not Connected" to connect the VIVO SX8 (dexi-piano-xx).



Wait until the VIVO SX8 is connected.

8. Tap "Done" to exit from the page.



Now you can change a tone, activate or deactivate a part, modify the octave, select functions and so on. Now if you want, you can control every function of your instrument by this application without using the VIVO SX8's panel anymore.



# 20 MENU Options (Advanced Section)

The VIVO SX8's [MENU] button provides access to the available parameters and functions.

## General procedure

### 1. Press the [MENU] button.

The display changes to:



### 2. Use the [DATA ENTRY] knob or the [▲] [▼] buttons to select the entry of the desired function group.

### 3. Press the [▶] button to go to the display page where you can edit the parameters of the selected group, or to execute the selected command.

For more details about the parameters selection, see "Moving the cursor and setting parameter values" (p. 17).

The following parameters and functions are available:

### Parameters Group

SOUND LIBRARY Functions	51
SOUND SETUP Functions	51
SOUND LIST	51
SETTING Parameters Group	51
PART1, PART2, PART3	51
TRANPOSE	51
VELOCITY	51
T2L EDITOR	51
EFFECTS	51
PART1 FX, PART2 FX, PART3 FX	51
REVERB	51
MASTER EQ	52
OUTPUT	52
CONTROL	52
DAMPER PEDAL	52
Part 1	52
Part 2	52
Part 3	52
PEDAL ASSIGN	52
Funct.	52
Part 1	52
Part 2	52
Part 3	52
EXPRESSION PEDAL	52
Funct.	52
Organ*	52
Part 1	52
Part 2	52
Part 3	52
TUNING	53
MASTER TUNE	53
TEMPERAMENT	53
Equal Flat	53
Equal Stretch (default)	53
VIVO Stretch	53
Vallotti	53
Just Major	53
Pythagorean	53
Mean-Tone	53

Werckmeister III	53
Kimberger III	53
User 1, User 2, User 3	53
MEMORY	54
USB MEMORY	54
REMOVE	54
FORMAT	54
USB AUDIO	54
BLUETOOTH	54
MIDI	55
RECEPTION	55
Memory	55
Status	55
Channel	55
TRANSMISSION	55
Memory	55
Status	55
Channel	55
MIDI SET	55
SAVE MIDI SET	55
EXPORT MIDI SET	55
IMPORT MIDI SET	55
GLOBAL	56
Auto OFF	56
Pedal	56
FACTORY RESET	56
FACTORY SOUND	56
BACKUP	56
PANIC	56
VERSION INFO	56

### NOTE

The parameters can be stored in various memory areas. The following table shows you how to know in which area it is stored.

Icons	Explanation
	This symbol indicates that the parameter or the parameters group can be stored in the Internal Memory area. See "Working with the Memories" (p. 42).
	This symbol indicates that the parameter or the parameters group can be stored in the Global Internal Memory area. The Global Internal Memory Area is automatically saved when you turn off the instrument.
<b>NOTE</b>	Use the appropriate button to turn off the instrument. Do not disconnect the power adapter from the outlet before the instrument is turned off.

## SOUND LIBRARY Functions

[MENU] button → SOUND LIBRARY

You can import sounds library in the internal memory of VIVO SX8 and use them in your performances. For details see "Additional Sound (Sound Library)" (p. 32).

## SOUND SETUP Functions

[MENU] button → SOUND SETUP

This is a useful function that allows you to prepare a sound set for a performance. If, in a performance, you will use only piano sounds, you can create a Sound Set that contain only piano sounds. In this way you can use the maximum size of internal memory of the module for piano sounds.

For details see "Sound Setup (Export/Import)" (p. 36).

## SOUND LIST

[MENU/EXIT] button → SOUND LIST

This function allows you to reorder the tone list. Please see "How to Reorder the Tone List" (p. 20).

## SETTING Parameters Group

[MENU] button → SETTING

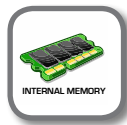

In this parameters group you can access to the important settings of your module.



### ▶ PART1, PART2, PART3

Please see "Parts & MIDI Settings" (p. 26).

### ▶ TRANSPOSE

This function allows you to transpose the VIVO SX8's pitch in semi-tone steps. For more details see "Transposing the Pitch of the Parts" (p. 26).

### ▶ VELOCITY

Each note that VIVO SX8 receives from MIDI has a velocity information. This value is the velocity measurement that simulate the behavior of a piano mechanism; a note struck on a piano is louder if the key is struck more forcefully.

Thank to this function you can modify the velocity curve as you wish.



1. Use the [◀][▶] buttons to select one of the 5 points that characterize the curve: "pp", "p", "mf", "f", "ff".
2. Use the [DATA ENTRY] knob or the [▲][▼] buttons to modify the value of the selected point.

Curve Point	Explanation
	"pp" standing for <i>pianissimo</i> and meaning "very soft".
	"p" standing for <i>piano</i> and meaning "soft".
	"mf" standing for <i>mezzo-forte</i> and meaning "half loud".
	"f" standing for <i>forte</i> and meaning "loud".
	"ff" standing for <i>fortissimo</i> and meaning "very loud".

3. Use the "RESET" Function button to restore the point at the default value.

Your velocity curve is automatically saved in the global area when the instrument is turned off.

## T2L EDITOR

[MENU] button → T2L EDITOR

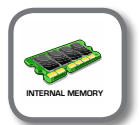

See "Personalizing Your Sounds" (p. 37).

## EFFECTS

[MENU] button → EFFECTS

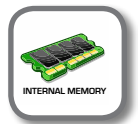

Your instrument contains three multi-effects (FX-A, FX-B and FX-C) processor that can be used for processing any part you like.

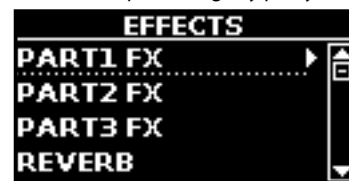

### ▶ PART1 FX, PART2 FX, PART3 FX

This selection provides access to the display pages where you can set the effects parameters of the VIVO SX8's parts.

For details see "Adding Effects to Orchestral Sound" (p. 29).

### ▶ REVERB

See "Adding Reverb to the Sound" (p. 29).

► MASTER EQ

See "Master Equalizer" (p. 30).

OUTPUT

[MENU] button →OUTPUT

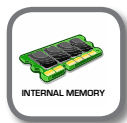

VIVO SX8 provides MAIN/SUB unbalanced output (TS jacks) in addition to MAIN balanced output (XLR jacks) as output destinations for the signal of the audio parts

As appropriate for your situation, you can choose which audio output to use (MAIN or SUB) for a certain part (Organ, Part1, Part2, Part3).



See "Specifying the Audio Output for Each Part" (p. 28).

CONTROL

[MENU] button →CONTROL



This group of parameters is related to the pedals controls. The VIVO SX8 allows you to manage and assign various function to the pedals connected to the PEDAL sockets. See "About the Pedals" (p. 12).

Here you can assign functions.



► DAMPER PEDAL

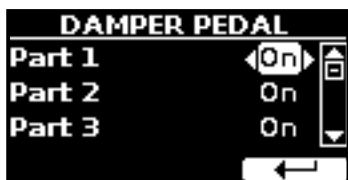

Parameter	Setting	Explanation
Part 1	OFF, ON	<b>OFF:</b> Select "OFF" if you don't need damper pedal for the relative part.
Part 2	default: ON	<b>ON:</b> the damper pedal is assigned to the relative part.
Part 3		

► PEDAL ASSIGN



Parameter	Setting	Explanation
	OFF	No function assigned.
	Sostenuto	The pedal is used as Sostenuto (default).
	Soft	The pedal is used as Soft The soft pedal reduces the volume and slightly changes the timbre of notes played while the pedal is pressed.
	Damper	The pedal is used as a damper.
	FXA On-Off	Allows you to switch the MFX A/B on and off.
	FXB On-Off	
	Memory Prev	Allows you to select the next or previous Memory.
	Memory Next	
	Rotary On/Off	Turns the rotary on or off.
	Rotary S/F	This function alternate between the fast and slow Rotary speeds.
	Rotary Brake	This function gradually stops the rotary. It does the same function as the [BRAKE] button in the ROTARY panel section.
	Perc. On/Off	Add or not the percussion. It does the same function as the [ON] button in the PERCUSSION panel section.
	VibChoOn/Off	Enable or disable the vibrato or chorus effect. It does the same function as the [ON] button in the VIBRATO/CHORUS panel section.
	Drive On/Off	This is the typical effect of vacuum tube amplifier. Add or not the overdrive effect It does the same function as the [OVERDRIVE] button in the ORGAN panel section.
	Part On/Off	Enable or disable the selected keyboard part.
	XMure FillUp	Using these functions you can select a the next or the previous drum pattern in the XMure® application.
	XMure FillDw	
	XMure SceneUp	These functions allow you to change scene of the accompaniment in the XMure® application.
	XMure SceneDw	
	XMure Play	Play or Stop the playback of a XMure® pattern.
	XMure Ending	Select the Ending pattern.
	TW Norm/Soft	This parameter reduce the volume of the tonewheel. See "VOLUME" in the "Organ Common" (p. 39).
	FXC On-Off	Allows you to switch the MFX C on and off.
Part 1		<b>OFF:</b> Select "OFF" if you don't need of pedal for the part. <b>ON:</b> the pedal is assigned to the specified part.
Part 2	OFF, ON default: ON	
Part 3		

► EXPRESSION PEDAL



Parameter	Setting	Explanation
	Expression, Modulation, FX-Manual, Sostenuto, Soft	<b>Expression:</b> The pedal is assigned to the expression. <b>Modulation:</b> The pedal is assigned to the Modulation. <b>FX-Manual:</b> You can control the "Manual" parameter of the effector. See the "16: Wah-Wah" (p. 59) and the "17: Cut Filter" (p. 60).
Organ*		<b>OFF:</b> Select "OFF" if you don't need of pedal. <b>ON:</b> the pedal is assigned to the specified part. * Only if the "Expression" function is selected .
Part 1	OFF, ON	
Part 2	default: ON	
Part 3		

# TUNING

[MENU] button → TUNING



## ▶ MASTER TUNE



Setting	Explanation
415.4 Hz~ 440.00 Hz~ 466.1 Hz	Select the desiderate tuning.
"440.00 Hz" Function button	Use the "440.00 Hz" and "442.00 Hz" Function buttons to tuning the instrument at those values.
"442.00 Hz" Function button	

### Some Information About the Master Tune

Pianos are generally tuned to an A 440 pitch standard that was adopted during the early 1900s in response to widely varying standards. Previously the pitch standards had gradually risen from about A 415 during the late 1700s and early 1800s to A 435 during the late 1800s. Though A 440 is generally the standard, some orchestras, particularly in Europe, use a higher pitch standard, such as A 444.

## ▶ TEMPERAMENT



The modern pianos are tuning in Equal Stretch temperament, in which every pair of adjacent pitches is separated by the same interval.

There are other scale used in different music style. Modern musical scale in western culture are different in one other way from older classic music. At the time of Bach the scales were based on the note A being about 415 Hz. In the Handel's time the frequency A was 422.5 Hz and today it is 440.0 Hz.

Setting	Explanation
Equal Flat	This tuning divides each octave into 12 equal steps (intervals).
Equal Stretch (default)	<b>Equal Stretch:</b> This tuning is a correction of Equal Flat. A benefit of stretching octaves is the correction of dissonance that equal temperament imparts to the perfect fifth.
VIVO Stretch	This tuning is similar to the Equal Sretch with small adjustments to make it more suitable for piano sounds.
Vallotti	This tuning is the default for many of today's Baroque musicians.

Setting	Explanation
Just Major	This is a just scale for pieces in mayor keys.
Pythagorean	This system was invented in ancient Greece. It resolves the ambiguity of fourths and fifths. Though thirds are somewhat imperfect, melodies sound clearer.
Mean-Tone	A temperament that adds some compromises to the just temperament and facilitates transposition.
Werckmeister III	A combination of the Mean Tone and Pythagorean temperaments, this tuning allows for playing in any key.
Kimberger III	As a result of improvements made to the Mean Tone and Just temperaments, this tuning system is relatively tolerant towards transposition and can be used to play in all keys.
User 1, User 2, User 3	<b>User 1, User 2, User 3:</b> These settings refer to the tuning systems programmed by yourself (or someone else).

1. Select your favorite temperament scale .
2. Press the "RECALL" Function button to load the scale.  
The temperament scale is recalled.

### Editing the Equal Flat, Equal Stretch or Vivo Stretch scale

If you selected the Equal Flat, Equal Stretch or Vivo Stretch scale:  
The "EDIT" Function button appears.

1. Press the "EDIT" Function button to program your scale.

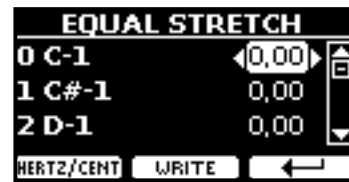

2. To select a note, use the [▲][▼] or play a note on the keyboard.
3. Use the [◀][▶] buttons or the [DATA ENTRY] knob to modify the tuning of the selected note.
4. Press [HERTZ/CENT] Function button to change the tuning in steps of 1/100 of cent.

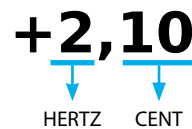

Setting	Explanation
-99.99 ~ 0 ~ +99.99 (cent)	Set the note tuning.

5. Press the "WRITE" Function button to save your scale.

The following page appears:



6. Use the [▲][▼] buttons to select the USER scale where you want save your scale.
7. Press the "WRITE" Function button to save your scale.  
A message of confirmation appears.

If you selected a scale other than equal temperament:

1. If you selected a scale other than equal temperament as Pythagorea, Mean-Tone, Werckmeister III, Kimberger III and the Just Major and Minor temperament scale, you can specify the root note:

The "ROOT NOTE" Function button appears.



2. Press the "ROOT NOTE" Function button if you want specify the base note.



3. Select the root note.

Setting	Explanation
C, C#, D, Eb, E, F, F#, G, Ab, A, Bb, B	Select the base note of the temperament scale.

4. Press the "←" Function button come back to previous page.

If you selected one of USER scales:

The "EDIT" Function button appears.



1. Press the "EDIT" Function button to program your scale.

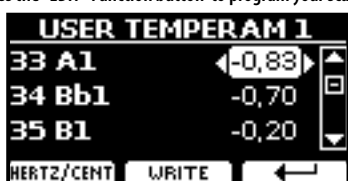

2. To select a note, use the [▲][▼] or play a note on the keyboard (if connected).
3. Use the [DATA ENTRY] knob or the [◀][▶] buttons to modify the tuning of the selected note.
4. Press [HERTZ/CENT] Function button to change the tuning in steps of 1/100 of cent.

Setting	Explanation
-99.99 ~ 0 ~ +99.99 (cent)	Set the note tuning.

5. Press the "WRITE" Function button to save your scale.  
A message of confirmation appears.
6. Press the "←" Function button come back to previous page.

## MEMORY

[MENU] button →MEMORY

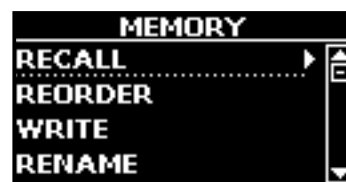
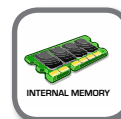

For the explanation of this section please refer to "Working with the Memories" (p. 42).

## USB MEMORY

[MENU] button →USB MEMORY



- ▶ REMOVE  
Before to unplug the USB Memory, use this function to safely remove it. See "Safely Remove the USB Memory" (p. 14).
- ▶ FORMAT  
Use this function to format your USB Memory. See "How to Format the USB Memory" (p. 13).

## USB AUDIO

[MENU] button →USB AUDIO



For details see "Adjusting the USB Audio" (p. 19).

## BLUETOOTH

[MENU] button →BLUETOOTH

VIVO SX8 is equipped with Bluetooth® Audio function. Thanks to this technology, you'll be able to stream music wirelessly from a Bluetooth® capable smartphone, tablet or computer to VIVO SX8. See "Wireless Function" (p. 48).

## MIDI

[MENU] button → MIDI

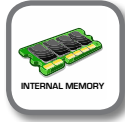

This group allow you to configure the MIDI parameters. You can transfer MIDI data between the VIVO SX8 and your sequencer software.



### ► RECEPTION



You can configure the MIDI receive parameters of Part 1, Part 2 and Part3. Additionally, you can manage the received MIDI messages for the memories and Organ control.

For **Part1, Part2, Part3 and Organ Control** please see "MIDI Reception" (p. 26).

For the Memory Part:



Memory		
Parameter	Setting	Explanation
Status	OFF, ON Default: On	Select "On" if you want to receive MIDI messages for the memories selection.
Channel	1 ~ 16 default: 15	Allows you to assign a MIDI receive channel to the "Memory" part.

### ► TRANSMISSION



You can configure the MIDI transmission parameters of Part 1, Part 2 and Part 3. Additionally, you can manage the transmitted MIDI messages for the memories and Organ control

For **Part1, Part2, Part3 and Organ control** please see "MIDI Transmission" (p. 27).

For the Memory Part:



Memory		
Parameter	Setting	Explanation
Status	OFF, ON Default: On	Select "On" if you want to transmit MIDI messages when you recall a memory. See "Working with the Memories" (p. 42).
Channel	1 ~ 16 default: 15	Allows you to assign a MIDI transmit channel to the "Memory" part.

### ► MIDI SET

MIDI Sets are memories for MIDI settings. The VIVO SX8 provides four MIDI Set memories.

The first MIDI Set, called "Dexibell", is read-only and allows you to restore the MIDI factory setting. The other three memories allow use to memorize and recall your MIDI configuration.



1. Use the [DATA ENTRY] knob or the [▲][▼] to select the MIDI Set and press the "RECALL" Function button to load it.
2. Press the "SAVE" Function button to jump in the SAVE MIDI SET page.

### ► SAVE MIDI SET



1. Use the [DATA ENTRY] knob or the [▲][▼] to select the MIDI Set memory and press the "WRITE" Function button to save your configuration.

### ► EXPORT MIDI SET

You can save your MIDI SET in a USB Memory.



1. Connect the USB Memory to which you wish to save the data. See "Connecting an USB Memory (commercially available)" (p. 13).
2. Use the "OPEN" function button to select the folder where you want save the data.
3. Press the "EXPORT" function button to perform the export operation.

### ► IMPORT MIDI SET

You can load your MIDI SET previous saved in a USB Memory.



1. Connect a USB Memory containing the previously saved MIDI SET data. See "Connecting an USB Memory (commercially available)" (p. 13).



2. Use the "OPEN" function button to select the folder that contains the data.
3. Press the "IMPORT" function button to perform the operation

## GLOBAL

[MENU] button →GLOBAL



These parameters allow you to adjust some global aspect of your piano. These parameters are automatically saved in the VIVO SX8 global memory area.



Parameter	Setting	Explanation
Auto OFF	Off, 5 min, 10 min, 30 min, 2 hours, 4 hours Default: 2 hours	This parameter allows you to cause the VIVO SX8 to switch itself off after the selected number of minutes has elapsed if you are not using it. Select "Off" if you prefer not to use this function.
Pedal	Global, Memory	<b>Global:</b> Set this value if you want the pedal assignments are saved in the global area. The pedal assignment does not depend on the recalled memory. <b>Memory:</b> Set this value if you want the pedal assignments are saved in the Memories. The pedal assignment depends on the recalled memory.

## FACTORY RESET

[MENU] button →FACTORY RESET

This function allows you to recall the VIVO SX8's original factory settings. Please see "Restoring the Factory Settings (Factory Reset)" (p. 30).

## FACTORY SOUND

[MENU] button →FACTORY SOUND

This function allows you to restore all sound libraries as they came out of the factory. Please see "Restore the Factory Sounds" (p. 30).

## BACKUP

[MENU/EXIT] button →BACKUP

Use this function to back up contents, settings, and sounds list from your VIVO SX8 into a USB Memory. See "How to Protect Your Settings, Contents and Sounds List (Backup)" (p. 31).

## PANIC

[MENU/EXIT] button →PANIC

Use this function if some operation on your instrument or an external tone generator (connected via a MIDI cable) has caused strange sounds or stuck some notes. See "Panic Function" (p. 31).

## VERSION INFO

[MENU] button →VERSION INFO

This page shows you the version number of the VIVO SX8's operating system.

# 21 Appendix

## Effects Types and Parameters List

### 1: Thru

The effects processor is bypassed.

### 2: EP Tremolo

This effect cyclically modulates (Speed) the amplitude (Intensity) to add tremolo to the sound. It's the electric piano typical effect.

Parameter	Setting	Explanation
Speed	0.10 ~ 12.50 Hz	Sets the speed of the tremolo effect.
Intensity	0 ~ 100	Depth to which the effect is applied.

### 3: Equalizer

This is a four-band stereo equalizer (low, mid x 2, high).

Parameter	Setting	Explanation
Low Freq	80 ~ 400	Selects the frequency of the low range.
Low Gain	-12 ~ 0 ~ +12	Adjusts the gain of the low frequency.
High Freq	800Hz ~ 8KHz	Selects the frequency of the high range.
High Gain	-12 ~ 0 ~ +12	Adjusts the gain of the high frequency.
Mid1 Freq	200Hz ~ 4KHz	Selects the frequency of the Mid1 range.
Mid1 Gain	-12 ~ 0 ~ +12	Adjusts the gain of the Mid1 frequency.
Mid1 Q	0.5 ~ 12.0	Move this parameter to adjust the width of the area around the Middle 1 frequency that will be affected by the Gain setting. Higher values of Mid1 Q set narrowest area.
Mid2 Freq	200Hz ~ 4KHz	Selects the frequency of the Mid2 range.
Mid2 Gain	-12 ~ 0 ~ +12	Adjusts the gain of the Mid2 frequency.
Mid2 Q	0.5 ~ 12.0	Move this parameter to adjust the width of the area around the Middle 2 frequency that will be affected by the Gain setting. Higher values of Mid2 Q set narrowest area.

### 4: Vibrato

Vibrato is a musical effect consisting of a regular, pulsating change of pitch. It is used to add expression to instrumental music.

Parameter	Setting	Explanation
Rate	0.10 ~ 12.50 Hz	Sets the speed of the vibrato effect.
Intensity	0 ~ 100	Allows you to set the vibrato intensity.

### 5: Flanger

This effect gives a significant swell and movement of pitch to the sound. It produces a metallic resonance effect.

Parameter	Setting	Explanation
Rate	0.10 ~ 12.50 Hz	Adjust the modulation speed.
Intensity	0 ~ 100	Allows you to set the flanger intensity.
Feedback	-96 ~ +96 %	Adjusts the proportion of the flanger sound that is fed back into the effect. Negative (-) settings will invert the phase.
Balance	0 ~ 100	Balance the Volume between the direct and the effect sound.

Parameter	Setting	Explanation
PreDelay	0 ~ 100 ms	Adjusts the delay from the direct signal and the moment when the flanger starts working.
Phase	0 ~ 180 deg	This sets the LFO phase difference between the left and right, in steps of 10 degrees It give more spatial of the sound.

### 6: Chorus

This effect adds thickness and warmth to the sound by modulating the delay time of the input signal. You can add spread to the sound by offsetting the phase of the left and right LFOs from each other.

Parameter	Setting	Explanation
Rate	0.10 ~ 12.50 Hz	Adjust the modulation speed.
Intensity	0 ~ 100	Allows you to set the chorus intensity.
Feedback	-96 ~ +96 %	Adjusts the proportion of the chorus sound that is fed back into the effect. Negative (-) settings will invert the phase.
Balance	0 ~ 100	Balance the Volume between the direct and the effect sound.
PreDelay	0 ~ 100 ms	Adjusts the delay from the direct signal and the moment when the chorus starts working.
Phase	0 ~ 180 deg	This sets the LFO phase difference between the left and right, in steps of 10 degrees.

### 7: Phaser

This effect creates a swell by shifting the phase. It is very effective on electric piano sounds. You can add spread to the sound by offsetting the phase of the left and right LFOs from each other.

Parameter	Setting	Explanation
Rate	0.10 ~ 12.50 Hz	Adjust the modulation speed.
Intensity	0 ~ 100	Allows you to set the phaser intensity.
Feedback	-96 ~ +96 %	Adjusts the proportion of the phaser sound that is fed back into the effect. Negative (-) settings will invert the phase.
Phase	0 ~ 180 deg	This sets the LFO phase difference between the left and right, in steps of 10 degrees.

### 8: Reverb

This effect adds reverberation to the sound, simulating an acoustic space as a room or a larger halls or stadiums.

Parameter	Setting	Explanation
Level	0 ~ 127	Set the quantity of Reverb effect
Damping	0 ~ 127	Adjusts the amount of damping of the room (Carpet, Wood, Brick, Concrete, Marble). Higher values increase the amount of high-frequency attenuation.
Room Size	0 ~ 127	It determines the size of the simulated room.
Width	0 ~ 127	Adjusts the stereo width of the Reverb effect. Higher value increase the stereo width.
PreDelay	0 ~ 100 ms	Adjusts the delay from the direct signal and the moment when the reverb starts working. This is used to simulate the distance between the original signal and the reflective surfaces.

## 9: Delay

The delay effect is used to simulate echo (repetition).

Parameter	Setting	Explanation
Delay L	0 ~ 750 ms	Sets the delay time for the left channel.
Delay R	0 ~ 750 ms	Sets the delay time for the right channel.
Feedback	-96 ~ +96 %	Adjusts the proportion of the delay sound that is fed back into the effect. Negative (-) settings will invert the phase.
Wet	0 ~ 100 %	Adjust the quantity of the delayed ("wet") signal.
Dry	0 ~ 100 %	Adjust the quantity of the unmodified ("dry") signal.

## 10: Cross Delay

Cross Delay allows you to create advanced stereo delay.

Each echo can be sent to the opposite channel from the source signal (echo of the left channel is heard on the right).

Parameter	Setting	Explanation
Delay L	0 ~ 750 ms	Sets the delay time for the left channel.
Delay R	0 ~ 750 ms	Sets the delay time for the right channel.
Feedback	-96 ~ +96 %	Adjusts the proportion of the delay sound that is fed back into the effect. Negative (-) settings will invert the phase.
Wet	0 ~ 100 %	Adjust the quantity of the delayed ("wet") signal.
Dry	0 ~ 100 %	Adjust the quantity of the unmodified ("dry") signal.

## 11: Triple Tap Delay

The Triple Tap Delay produces three delay sounds: center, left and right.

Parameter	Setting	Explanation
Delay L	0 ~ 750 ms	Sets the delay time for the left channel.
Delay R	0 ~ 750 ms	Sets the delay time for the right channel.
Delay C	0 ~ 750 ms	Sets the delay time for the center (L+R) channel.
Feedback	-96 ~ +96 %	Adjusts the proportion of the delay sound that is fed back into the effect. Negative (-) settings will invert the phase.
Level L	0 ~ 100	Adjust the volume of the left delay sound.
Level R	0 ~ 100	Adjust the volume of the right delay sound.
Level C	0 ~ 100	Adjust the volume of the center delay sound.
Wet	0 ~ 100 %	Adjust the quantity of the delayed ("wet") signal.
Dry	0 ~ 100 %	Adjust the quantity of the unmodified ("dry") signal.

## 12: Rotary

The rotary is a typical effect generated by the rotation of the speakers, this rotation creates a Larsen effect. It gives spaciousness to the sound.

Parameter	Setting	Explanation
Speed	Slow, Fast	Switches the speaker rotation speed between slow and fast.
Brake	Off, On	This parameter allows you to manually control the wheel brake. Off is the default; the tone wheels will turn normally. Changing this to On will make the tone wheels gradually slow down and stop.
Vibrato Sw	Off, On	Disable and enable the vibrato effect.
Vibrato Type	V1, C1, V2, C2, V3, C3	This selects one of the six classic Vibrato/Chorus presets. "V" stands for Vibrato, and "C" stands for Chorus.

## 13: Tremolo

This effect cyclically modulates (Speed) the amplitude (Intensity) to add tremolo to the sound.

Parameter	Setting	Explanation
Speed	0.10 ~ 12.50 Hz	Sets the speed of the tremolo effect.
Intensity	0 ~ 100	Depth to which the effect is applied.

## 14: Tremolo Pan

This effect is similar to the Tremolo. It include an extra parameter that indicate the phase between the left or right channel.

Parameter	Setting	Explanation
Speed	0.10 ~ 12.50 Hz	Sets the speed of the tremolo effect.
Intensity	0 ~ 100	Depth to which the effect is applied.
Phase	0 ~ 180 deg	This sets the LFO phase difference between the left and right, in steps of 10 degrees.

## 15: Overdrive

This effect is designed to work and sound like an old tube amp turned up loud. It suitable for hard rock and similar musical genres.

Parameter	Setting	Explanation
Drive	1 ~ 100	Higher Drive settings, mean more distortion.
Tone	100 Hz ~ 10.0 KHz	Use this parameter to accent or attenuate certain dominant or unwanted overtones.
Level	0 ~ 100	Increase or decrease the volume of the effect.
Low Freq	80 ~ 400	Selects the frequency of the low range.
Low Gain	-12 ~ 0 ~ +12	Adjusts the gain of the low frequency.
High Freq	800Hz ~ 8KHz	Selects the frequency of the high range.
High Gain	-12 ~ 0 ~ +12	Adjusts the gain of the high frequency.

## 16: Wah-Wah

It is a type of effect that alters the tone and frequencies of the input signal to create a unique sound, mimicking the human voice and taking the onomatopoeic name "Wah-Wah".

Parameter	Setting	Explanation
Mode	Auto, Manual	<b>Auto:</b> The "Manual" parameter is automatically controlled by the internal LFO. <b>Manual:</b> The "Manual" parameter is controlled by the expression pedal or the WHELL 2 (if your instrument is equipped with WHELL 2). Remember that in addition, the Expression Pedal socket must be assigned to the function "FX-MANUAL". See "Added a New Function to the Expression Pedal and Wheel2 (FX MANUAL)" (p. 10).
Manual	0 ~ 127	Adjusts the center frequency at which the effect is applied. This parameter can be also controlled by the expression pedal or the WHELL 2 (if your instrument is equipped with WHELL 2). Remember that in addition, the Expression Pedal socket must be assigned to the function "FX-MANUAL". See "EXPRESSION PEDAL" (p. 53).
Filter	Low Pass, High Pass, Band Pass, Peak	<b>Low Pass:</b> The wah effect will be applied over a low frequency range. <b>High Pass:</b> The wah effect will be applied over a high frequency range. <b>Band Pass:</b> The wah effect will be applied over a narrow frequency range. <b>Peak:</b> The wah effect will be applied over a specific center frequency.
Low Freq	100Hz ~ 10.0KHz	Selects the frequency of the low range.
High Freq	100Hz ~ 10.0KHz	Selects the frequency of the High range.
Low Q	0.5 ~ 10.0	Move this parameter to adjust the width of the area around the Low or High Frequency.
Hi Q	0.5 ~ 10.0	
LFO Rate	0.1Hz ~ 12.50Hz	Frequency of modulation.
LFO Curve	Linear, Quadratic	LFO curve trend.
Balance	0% ~ 100%	Adjusts the balance between original and the effect sound.
Env Threshold	-40dB ~ 0dB	Adjust the threshold of the envelop
Env Attack	0ms ~ 250ms	Adjust the attack of the envelop
Env Release	0ms ~ 1000ms	Adjust the release of the envelop

Parameter	Setting	Explanation
Low Freq	100Hz ~ 10.0KHz	Selects the frequency of the low range.
High Freq	100Hz ~ 10.0KHz	Selects the frequency of the High range.
Low Q	0.5 ~ 10.0	Move this parameter to adjust the width of the area around the Low or High Frequency.
Hi Q	0.5 ~ 10.0	

## 18: Compressor

This filter that attenuates ("cut") some frequency range.

Parameter	Setting	Explanation
Threshold	-40dB ~ 0dB	The compression is activated only when the input signal exceeds the threshold level. Input levels above the threshold will be compressed, and input levels below the threshold will not be compressed.
Ratio	1:1 ~ inf:1	This parameter determines how strong is the compression. <ul style="list-style-type: none"> <li>At 1:1, the compressor has no effect.</li> <li>For all other values the output signal will be compressed in according to the ratio value.</li> <li>At Inf:1, the compressor becomes a brick-wall limiter; once the signal hits the Threshold, the output level will no longer increase, regardless of the input level.</li> </ul>
Knee Width	0.0 ~ 1.0	Increasing this value will produce a more soft volume change around the Threshold level.
Attack Time	0ms ~ 250ms	This parameter determines how quickly the compressor will take affect after the signal crosses above the threshold.
Release Time	0ms ~ 1000ms	This parameter controls how quickly the compressor will stop reducing volume level after the signal falls below the threshold.
Makeup	-24dB ~ -24dB	Allows you to boost the compressed signal as compression often attenuates the signal significantly.
Stereo Link	Off, On	Set the parameter "On" to operate in stereo mode.

## 17: Cut Filter

This filter that attenuates ("cut") some frequency range.

Parameter	Setting	Explanation
Manual	0 ~ 127	Adjusts the center frequency at which the effect is applied. This parameter can be also controlled by the expression pedal or the WHELL 2 (if your instrument is equipped with WHELL 2). Remember that in addition, the Expression Pedal socket must be assigned to the function "FX-MANUAL". See "EXPRESSION PEDAL" (p. 53).
Slope	12db/Octave, 24db/Octave	The slope of filter attenuation is usually quantified in decibels per octave.
Type	Low Pass, High Pass, Band Pass, Peak	<b>Low Pass:</b> Attenuates the frequencies above a cutoff frequency, allowing low frequencies to pass through the filter. <b>High Pass:</b> Attenuates the frequencies below a cutoff frequency, allowing high frequencies to pass through the filter. <b>Band Pass:</b> The filter is applied over a narrow frequency range. <b>Peak:</b> The filter is applied over a specific center frequency.

# VIVO SX8's Tone List

Num.	Name	PC	CC00 (MSB)
<b>PIANO</b>			
0001	Italian Live PLT	1	71
0002	Italian PLT	1	70
0003	Italian Classic PLT	1	72
0004	Italian Bright PLT	1	73
0005	Italian Memory PLT	1	74
0006	USA Live PLT	1	61
0007	USA PLT	1	60
0008	USA Classic PLT	1	62
0009	USA Bright PLT	1	63
0010	USA Memory PLT	1	64
0011	VIVO Upright	1	2
0012	Elec.Grand	3	2
0013	E.Grand Trem	3	3
0014	Rock Piano	3	1
<b>E. PIANO</b>			
0015	EPBell Chorus PLT	5	107
0016	EPBell Phaser PLT	5	108
0017	EPBell Tremolo PLT	5	109
0018	EPBell OD PLT	5	110
0019	EPBell Phr+Trm PLT	5	111
0020	EPBell Flanger PLT	5	113
0021	EPBell HardOD PLT	5	114
0022	EPBell Bri+Cho PLT	5	115
0023	EPBell PLT	5	106
0024	70s EP Chorus PLT	5	101
0025	70s EP Phaser PLT	5	102
0026	70s EP Tremolo PLT	5	103
0027	70s EP OD PLT	5	104
0028	70s EP Phr+Trm PLT	5	105
0029	70s EP Bright PLT	5	116
0030	70s EP Bri+Cho PLT	5	117
0031	70s EP Bri+Pha PLT	5	118
0032	70s EP Bri+Tre PLT	5	119
0033	70s EP PLT	5	100
0034	Dirty EPBell PLT	5	112
0035	Dyno Stage	5	0
0036	Dyno Trem	5	7
0037	Dyno Bell	5	8
0038	Suitcase	5	1
0039	Phaser EP	5	2
0040	Wurly	5	5
0041	Trem.Wurly	5	6
0042	Soft E.Piano	5	3
0043	Bright E.Piano	5	4
0044	FM Full Tines	6	0
0045	FM E.Piano	6	1

Num.	Name	PC	CC00 (MSB)
<b>PERCUSSIVE</b>			
0046	Doctor Clav	8	2
0047	Cool Clav	8	0
0048	Funky Clav	8	3
0049	Groovy Clav	8	1
0050	Wah-Wah Clav	8	4
0051	Drive Clav	8	5
0052	Vibraphone	12	0
0053	Marimba	13	0
0054	Celesta	9	0
<b>ORGAN TW</b>			
More than 100 preset. See "VIVO SX8's Organ Preset List" (p. 62)			
<b>STRINGS</b>			
0055	Easy Strings	50	10
0056	FastOrchestra	50	4
0057	Attack Strings	49	2
0058	Choir Strings	52	1
0059	Large Strings	50	5
0060	MellowStrings	50	6
0061	Soft Strings	50	7
0062	5th Strings	50	8
0063	Slow Analog	50	9
0064	Orchestra	49	1
0065	80's Strings	52	0
0066	Syn. Strings	51	1
0067	Pizzicato	46	0
0068	Strings Pad	51	0
0069	StrTape1Dry	49	100
0070	StrTape1Rev	49	101
0071	StrTape1Cut	49	102
0072	CllTape2Dry	43	103
0073	CllTape2Rev	43	104
0074	CllTape2Cut	43	105
0075	VlnsTape1Dry	50	100
0076	VlnsTape1Rev	50	101
0077	VlnsTape1Cut	50	102
<b>PAD/CHOIR</b>			
0078	Dexi Heaven	101	1
0079	Fanta Bell	101	0
0080	Warm Pad	90	0
0081	Soft Pad	90	1
0082	Square Pad	90	2
0083	90's Pad	51	2
0084	Space Vox	55	1
0085	Mmh Choir	53	0
0086	Choir Pad	54	1

Num.	Name	PC	CC00 (MSB)
0087	FlutTape1Dry	74	100
0088	FlutTape1Rev	74	101
0089	FlutTape1Cut	74	102
0090	FemlTape2Dry	53	103
0091	FemlTape2Rev	53	104
0092	FemlTape2Cut	53	105
0093	BoysTapeDry	53	100
0094	BoysTapeRev	53	101
0095	BoysTapeCut	53	102
0096	MaleTape1Dry	53	106
0097	MaleTape1Rev	53	107
0098	MaleTape1Cut	53	108
<b>BRASS/SYNTH</b>			
0099	Full Brass	62	3
0100	Synth Brass	63	0
0101	Poly Brass	63	1
0102	Analog Brass	63	2
0103	Fat Syn Brass	63	3
0104	Trumpet Sect.	57	3
0105	Trumpet	57	2
0106	Horns	61	0
0107	Tenor Sax	67	0
0108	Alto Sax	66	0
0109	Flugelhorn	57	1
0110	Soprano Sax	65	0
0111	Classic Trumpet	57	0
0112	Lucky Lead	83	0
0113	Expressive	83	1
0114	ExpressiveFat	83	2
0115	ExpressiveBell	83	3
0116	Mellow Lyle	83	4
0117	Octave OSC	83	5
0118	Mellow Lead	83	6
0119	Clear Lead	83	7
0120	Saw Solo	83	8
0121	OSC Sync	83	9
0122	Mini Square	83	10
0123	Mini Triangle	83	11
0124	Triangle	83	12
0125	Pure Sine	83	13
0126	Saw Square	83	14
0127	Clear SawSqr	83	15
0128	70's SawSqr	83	16
0129	2600 Pulse 50	83	17
0130	2600 Pulse 20	83	18
0131	2600 PulseOD	83	19
0132	Clear PW	83	20

Num.	Name	PC	CC00 (MSB)
0133	OB Synth 1	81	0
0134	OB Synth 2	81	1
0135	OB Synth 3	81	2
0136	OB Synth 4	81	3
0137	Lyle Lead	81	4
0138	Super Saw	91	1
0139	Synth Lead 1	82	0
0140	Synth Mellow	82	1
0141	Synth Lead 2	82	2
0142	Synth Lead 3	82	3
0143	Synth Lead 4	82	4
0144	Fast Synth	91	2
0145	Poly Saw	91	3
0146	Euro Synth	91	4
0147	Euro Stack	94	0
0148	Poly Chord	94	1
0149	Synth Vox	55	0

Num.	Name	PC	CC00 (MSB)
0150	Urban Harp	47	1
<b>GIUITAR/BASS</b>			
0151	Nylon Guitar	25	0
0152	Power GT.	30	1
0153	Muted GT.	30	2
0154	Jazz Guitar	27	0
0155	Rock Bass	35	1
0156	RockSlapBass	38	0
0157	RockSoftSlap	38	1
0158	Elec.Bass	34	2
0159	El.Bass Dark	34	3
0160	Soft Slap Bs	37	0
0161	Hard Slap Bs	37	1
0162	Pop Big Bass	34	4
0163	Pop Bass	34	5

Num.	Name	PC	CC00 (MSB)
0164	Pop Elec.Bass	34	6
0165	Fat Bass	34	7
0166	Contemp.Bass	34	8
0167	PalmMutingBs	34	9
0168	Old Muted	35	2
0169	Fretless Bass	36	0
0170	Upright Bass	33	7
0171	Pedal Bass	39	5
0172	Pedal DoubleBs	33	5
0173	Modular Bass	39	1
0174	Fat Bass	39	2
0175	Reso Bass	39	3
0176	Big Reso Bass	39	4
0177	FM Bass	40	3
0178	Synth Bass	39	0

## VIVO SX8's Organ Preset List

Num.	Upper Preset	Lower Preset	Pedal Preset
<b>TW1/TW2</b>			
0001	00 5320 000	00 4545 440	73
0002	00 4432 000	00 4423 220	85
0003	00 8740 000	00 7373 430	80
0004	00 4544 222	00 4544 220	08
0005	00 5403 000	00 6644 322	28
0006	00 4675 300	00 5642 200	
0007	00 5645 320	00 6845 433	
0008	00 6876 540	00 8030 000	
0009	32 7645 222	42 7866 244	
0010	88 8000 000	60 6000 000	
0011	87 8000 456	88 00 70 770	
0012	88 8800 000	83 8000 000	
0013	86 8600 008	00 4440 000	
0014	80 8800 008	20 7004 000	
0015	87 6543 211	00 6620 000	
0016	88 5324 588	00 7500 000	
0017	80 8000 008	80 8400 008	
0018	88 8233 211		
0019	86 4200 357		
0020	68 6040 000		
0021	88 8604 000		
0022	80 0008 888		
0023	00 8800 000		
<b>FARF</b>			
0001	08 0088 888	80 8000 008	80
0002	80 8000 808	08 0000 800	88

Num.	Upper Preset	Lower Preset	Pedal Preset
0003	80 8080 808	80 8080 008	
0004	08 0888 808	00 8088 800	
0005	08 8880 800	00 0880 080	
<b>VX</b>			
0001	38 8033 078	03 8800 367	88 0000 080
0002	80 8000 008	08 8000 008	08 0000 088
0003	88 8026 057	08 0800 557	88 0000 008
0004	08 0048 088	03 8000 667	88 0000 088
0005	88 0048 056	05 6700 475	80 0000 088
<b>PIPE</b>			
0001	00 8000 000	08 0000 000	800
0002	08 8000 000	88 0000 000	880
0003	08 8800 000	88 8000 000	888
0004	08 8880 000	88 8800 000	080
0005	88 8888 000	88 8808 000	808
<b>USER 1</b>			
0001	00 8000 000	08 0000 000	800 0000 000
0002	08 8000 000	88 0000 000	880 0000 000
0003	08 8800 000	88 8000 000	888 0000 000
0004	08 8880 000	88 8800 000	080 0000 000
0005	88 8888 000	88 8808 000	808 0000 000
<b>USER 2</b>			
0001	00 8000 000	08 0000 000	800 0000 000
0002	08 8000 000	88 0000 000	880 0000 000
0003	08 8800 000	88 8000 000	888 0000 000
0004	08 8880 000	88 8800 000	080 0000 000
0005	88 8888 000	88 8808 000	808 0000 000

## Drawbars MIDI Controls

CC number	Value	Description	Part	Draw-faders
CC 16	0 ~ 127	0 = 0 1 = 1 2 = 2 3 = 3 4 = 4 5 = 5 6 = 6 7 = 7 8 = 8	Main	Drawbars 16'
CC 17			Main	Drawbars 5 1/3'
CC 18			Main	Drawbars 8'
CC 19			Main	Drawbars 4'
CC 20			Main	Drawbars 2 2/3'
CC 21			Main	Drawbars 2'
CC 22			Main	Drawbars 1' 3/5'
CC 23			Main	Drawbars 1 1/3'
CC 24			Main	Drawbars 1'
CC 70			Lower	Drawbars 16'
CC 71			Lower	Drawbars 5 1/3'
CC 72			Lower	Drawbars 8'
CC 73			Lower	Drawbars 4'
CC 74			Lower	Drawbars 2 2/3'
CC 75			Lower	Drawbars 2'
CC 76			Lower	Drawbars 1' 3/5'
CC 77			Lower	Drawbars 1 1/3'
CC 78			Lower	Drawbars 1'
CC 14			Pedal	Drawbars 16'
CC 15			Pedal	Drawbars 5 1/3'
CC 25			Pedal	Drawbars 8'
CC 26			Pedal	Drawbars 4'
CC 27			Pedal	Drawbars 2 2/3'
CC 28			Pedal	Drawbars 2'
CC 29			Pedal	Drawbars 1' 3/5'
CC 30			Pedal	Drawbars 1 1/3'
CC 31			Pedal	Drawbars 1'

CC number	Value	Description	Percussion
CC 87	0 ~ 63~ 64 ~127	0 = Off, 1 = On	On/Off
CC 88		0 = Normal, 1 = Soft	Normal/Soft
CC 89		0 = Slow, 1 = Fast	Slow/Fast
CC 95		0 = 2nd, 1 = 3rd	2nd/3rd

CC number	Value	Description	Vibrato
CC 84	1,2,3,4,5,6	1 = V1, 2 = C1, 3 = V2, 4 = C2, 5 = V3, 6 = C3	Vibrato mode
CC 69	0 ~ 63~ 64 ~127	0 = Off, 1 = On	ON/OFF panel

CC number	Value	Description	Rotary Leslie
CC 80 (general purpose)	0 ~ 63~ 64 ~127	0 = Off, 1 = On	On/Off
CC 82 (general purpose)		0 = Slow, 1 = Fast	Slow/Fast
CC 81 (general purpose)		0 = Off, 1 = On	Brake On/Off

CC number	Value	Description	Overdrive
CC 83	0 ~ 63~ 64 ~127	0 = Off, 1 = On	On/Off
CC 92	1 ~ 100		Drive
CC 94			Tone
CC 90			Level

# 22 Troubleshooting

Symptom	Action	Page
Power turns automatically off.	This is normal and due to the Auto Power Off function. If necessary, set the parameter of the Auto Power Off function. If you don't need the power to turn off automatically, turn the "AUTO OFF" setting "Disable".	57
The instrument does not turn on.	Is the AC adaptor/power cord correctly connected to an AC outlet and to the VIVO SX8? <b>NOTE</b> Do not use any AC adaptor or power cord other than the ones included. Doing so will cause malfunctions.	12
	Could you have turned the power on again immediately after turning the power off? Allow an interval of at least five seconds before turning the power on again.	-
No sound from the VIVO SX8's OUTPUT sockets.	Did you switch the VIVO SX8 on?	14
	Could the [VOLUME] knob be turned down? Select a higher setting.	-
	Could the volume be lowered by a pedal operation? Move the pedal fully "toe down" to maximize volume.	-
	Could the part volume settings have been minimized? Check the "Level" setting of each part.	26
	Have you connected a MIDI keyboard or a personal computer to the VIVO SX8? Check whether the MIDI transmission channels of the external keyboard or computer correspond to the VIVO SX8's reception channels.	18 18
The volume level of the instrument is too low when it is connected to an amplifier.	Could you be using a connection cable that contains a resistor? Use a connection cable that doesn't contain a resistor.	-
Insufficient volume from or to a device connected to the VIVO SX8's USB port.	Could the USB AUDIO Input Level be down? Select a higher setting.	19
	Could the USB AUDIO Output Level be down? Select a higher setting.	19
The pitch of the instrument is incorrect.	Is the "Tuning" or "Temperament" setting appropriate? Check the parameters.	54
	Did you transpose the instrument?	52
	Could the pitch have been changed by a pitch bend message received from an external MIDI device?	-
A "buzz" is heard from the external amplifier.	Is the external amplifier or other device used with the VIVO SX8 connected to a different AC power outlet? Connect the amplifier or other device to the same AC outlet as the VIVO SX8.	-
	The noise may be due to interference caused by the use of a mobile phone in close proximity to the instrument. Turn off the mobile phone, or use it further away from the instrument.	-
After connecting the VIVO SX8's USB COMPUTER port to your computer, the VIVO SX8 doesn't receive MIDI messages.	The VIVO SX8 may be receiving on a MIDI channel on which the MIDI controller doesn't transmit. Correct the MIDI controller's transmit channel.	56
Unable to read from/write to USB Memory.	Check the format of your USB Memory. The VIVO SX8 can use USB Memory that has been formatted as FAT. If your USB Memory was formatted using any other method, please re-format it as MS-DOS FAT.	-
Can't save to USB Memory.	Could the USB Memory be write protected?	-
	Is there sufficient free space on the USB Memory?	-
This "dexi-piano-xx" model name does not appear in the Bluetooth device list of your mobile device.	Have you made the instrument visible to other devices?	48
The music data played back by the mobile device cannot be heard through the VIVO SX8.	Was the pairing function initiated between this unit and the mobile device?	48



# 23 Specifications

ITEMS		VIVO   SX8
TONE GENERATOR	T2L: Sampling and Modelling Technology	
MODELLING	Reactive to player articulation	
SAMPLING	XXL wave size, holophonic recording up to 15 seconds on lower piano notes	
SOUND WAVE FORMAT	24 bit linear - 48 KHz (Internal processing and DSP at 32 bit floating)	
DIGITAL ANALOG CONVERSION (DAC)	24 bit linear - 48 KHz, Dynamic Range, S/N:106dB	
MAXIMUM POLYPHONY	Unlimited with 320 Oscillator	
ORGAN TYPES	TW1, TW2, FARF, VX, PIPE + User1, User2 downloadable from website	
SOUNDS	Over 100 Organ Preset + 178 Sounds + User downloadable from website (Compatible with .sf2)	
MEMORY	Internal: 80 User: Unlimited loadable from USB Memory	
MIDI PART	3	
MIDI TOUCH SENSITIVITY	Velocity adjustment (pp, p, mf,ff)	
REVERB	24 Types	
EFFECTS	Rotary, Overdrive, Vibrato/Chorus for Organ + 9 independent DSP Effects ( 3 x 3 Parts) using "seamless changes" technology at effect recall	
MASTER EQUALIZER	3-band Digital Equalizer	
MASTER TUNING	YES: 415,4Hz to 466,1 Hz (adjustable increments of 0,1 Hz) + 2 Preset (440 Hz, 442 Hz)	
TEMPERAMENT	9 Types	
USER TEMPERAMENT	3 User	
WIRELESS CONNECTION	Audio and MIDI Bluetooth® (4.2 Low Energy) Wi-Fi TM (ready for future software version)	
RHYTHM PATTERNS	X MURE APP for i-Phone and i-Pad (FREE) with multitracks audio patterns	
DISPLAY	Graphic LCD 128 x 64 dots Organic LED, high contrast type	
CONNECTORS	DC IN socket	for supplied AC adaptor
	Unbalanced Output (L/Mono, R) jacks	Assignable as SUB OUTPUT 1/4-inch phone type x 2
	Balanced Output (L, R)	XLR type x 2
	Phones jacks	1 x Stereo 1/4-inch phone type
	USB COMPUTER (Type B port)	Digital Audio OUT on USB (24 bit, 48 KHz) Digital Audio IN on USB (24 bit, 48 KHz)
	USB MEMORY (Type A port)	To Host (MIDI), To Device (MEMORY)
	MIDI sockets	IN, THRU
	DAMPER Pedal (HOLD) socket	Progressive Damper Action Pedal with sympathetic resonance simulation (Accept on/off pedal also)
	ASSIGN Pedal socket	Assignable (default Expression)
Power Supply	12V DC 2A , supplied AC/DC adaptor	
POWER CONSUMPTION	Stand By: < 0,2 W Maximum: < 9 W "ErP" LEVEL VI for Echo efficiency on stand-by consumption	
DIMENSIONS	292 (W) x 173 (D) x 87 mm (H) 11-1/2 (W) x 6-13/16 (D) x 3-7/16 (H) inches	
WEIGHT	1.9 kg (excluding AC adaptor) 4 lbs 4 oz (excluding AC adaptor)	
SUPPLIED ACCESSORIES	Quick guide AC adaptor (DEXIBELL DYS624-120200W) 2 Rack-mount bracket	
OPTIONS (sold separately)	DX CP1 continuous sustain pedal with selectable 'mode switch (Switch, continuous) DX SP1 switch pedal with selectable mode switch (normally closed, normally open) DX HF7 Stereo headphones	

## NOTE

In the interest of product, the specification and description are subject to change without notice.

# 24 Index

## Simboli

### A

AC Adaptor .....	12
Adding a Library .....	33
Audio Level (USB) .....	19
AUTO OFF .....	15

### B

Bluetooth® .....	47
------------------	----

### C

Computer .....	19
Connect a MIDI Keyboard .....	18
CONTROLS .....	52
Cursor .....	16
Cursor Operation .....	16
Moving the cursor .....	17

### D

DAMPER PEDAL .....	52
DC IN jack .....	12
Demo .....	15
Display .....	16

### E

Effect	
Reverb Effect .....	29
EFFECTS .....	51
Export	
Exporting the Internal Memory Set .....	44
Exporting a Sound Set .....	35

### F

Factory Reset .....	30
Factory Sounds .....	30
File name	
Assigning the Name You Specify .....	17

### G

GLOBAL .....	56
--------------	----

### H

Harmonic Percussion .....	23
Headphones .....	13

### I

Import	
Importing Memory Set .....	44
Importing a Sound Set .....	35

### J

### K

## L

### M

MAIN SETTING .....	51
Master Equalizer .....	30
MASTER TUNE .....	53
Memories	
Exporting the Internal Memory Set in the USB Memory .....	44
Importing Memory Set from the USB Memory into Internal Memory. .....	44
Recalling your settings from an USB Memory .....	43
Recalling your settings from Internal Memory .....	41
Renaming a Memory .....	43
Saving Your Settings in the Internal Memory .....	41
Working with the Memories .....	41
MEMORY .....	54

### MENU

MENU Options (Advanced Section) .....	50
MIDI .....	55
MIDI Channels .....	18
MIDI Reception .....	26
MIDI Settings .....	26

## N

### O

Organ Section .....	22
Organ Types .....	22
Overdrive .....	24

### P

Parameters	
GLOBAL .....	56
Part Settings .....	26
passkey .....	47
PEDAL	
DAMPER PEDAL .....	52
PEDAL ASSIGN .....	52
Pitch of the Parts .....	26
Power On/Off .....	14
Turning the Power On/Off .....	14
Presetted Organ .....	22

## Q

### R

Rename	
Renaming a Memory .....	43
Reverb	
Reverb Effect .....	29
REVERB .....	51

### S

Save	
Saving Your Settings in the Internal	

Memory .....	41
Saving Your Settings in the USB Memory .....	42

### SETTING

SETTING Parameters Group .....	51
Sound Effects .....	29
Sound Library .....	32
Sounds	
Personalizing Your Sounds .....	36
Sound Setup .....	35
Specifications .....	64
Split	
Splitting the Keyboard Range and Playing Two Different Tones .....	20

## T

T2L EDITOR .....	51
T2L-Modelling .....	36
TEMPERAMENT .....	53
Tones	
Selecting Tones .....	20,26
Transpose	
Transposing the pitch of the keyboard or/and song .....	30
TRANPOSE .....	51
Troubleshooting .....	63
TUNE	
MASTER TUNE .....	53
TUNING .....	53

## U

USB Audio Feature .....	19
USB Audio Level .....	19
USB FORMAT .....	13
USB Memory	
Connecting an USB Memory .....	13
Exporting the Internal Memory Set in the USB Memory .....	44
Importing Memory Set from the USB Memory into Internal Memory. .....	44
Recalling your settings from an USB Memory .....	43
Saving Your Settings in the USB Memory .....	42
USB MIDI .....	18

## V

VOLUME knob .....	8
-------------------	---

## W

Wireless	
Already Paired Mobile Device .....	48

## X

X MURE .....	46
--------------	----

## Y

## Z



This product complies with the requirements of EMC Directive 2014/30/EU.

For European Countries

For Canada

## NOTICE

This Class B digital apparatus meets all requirements of the Canadian Interference-Causing Equipment Regulations.

## AVIS

Cet appareil numérique de la classe B respecte toutes les exigences du Règlement sur le matériel brouilleur du Canada.

### IMPORTANT NOTICE FOR THE UNITED KINGDOM

**IMPORTANT: THE WIRES IN THIS MAINS LEAD ARE COLOURED IN ACCORDANCE WITH THE FOLLOWING CODE.**

BLUE: NEUTRAL  
BROWN: LIVE

As the colours of the wires in the mains lead of this apparatus may not correspond with the coloured markings identifying the terminals in your plug, proceed as follows:

The wire which is coloured BLUE must be connected to the terminal which is marked with the letter N or coloured BLACK.  
The wire which is coloured BROWN must be connected to the terminal which is marked with the letter L or coloured RED.  
Under no circumstances must either of the above wires be connected to the earth terminal of a three pin plug.

### European Community Declaration of Conformity

English	Hereby, DEXIBELL, declares that this VIVO SX8 is in compliance with the essential requirements and other relevant provisions of Directive 2014/53/EU.
Italiano [Italian]	Con la presente DEXIBELL dichiara che questo VIVO SX8 è conforme ai requisiti essenziali ed alle altre disposizioni pertinenti stabilite dalla direttiva 2014/53/UE.
Français [French]	Par la présente DEXIBELL déclare que l'appareil VIVO SX8 est conforme aux exigences essentielles et aux autres dispositions pertinentes de la directive 2014/53/UE.
Deutsch [German]	Hiermit erklärt DEXIBELL, dass sich das Gerät VIVO SX8 in Übereinstimmung mit den grundlegenden Anforderungen und den übrigen einschlägigen Bestimmungen der Richtlinie 2014/53/EU befindet.
Nederlands [Dutch]	Hierbij verklaart DEXIBELL dat het toestel VIVO SX8 in overeenstemming is met de essentiële eisen en de andere relevante bepalingen van richtlijn 2014/53/UE.
Español [Spanish]	Por medio de la presente DEXIBELL declara que el VIVO SX8 cumple con los requisitos esenciales y cualesquiera otras disposiciones aplicables o exigibles de la Directiva 2014/53/UE.
Português [Portuguese]	DEXIBELL declara que este VIVO SX8 está conforme com os requisitos essenciais e outras disposições da Directiva 2014/53/UE.
български [Bulgarian]	С настоящото DEXIBELL декларира, че това устройство VIVO SX8 е в съответствие със съществените изисквания и други приложими разпоредби на Директиви 2014/53/ЕС
Hrvatski [Croatian]	DEXIBELL ovim putem izjavljuje da je ovaj uređaj VIVO SX8 sukladan osnovnim zahtjevima i ostalim bitnim odredbama Direktiva 2014/53/EU
Česky [Czech]	DEXIBELL tímto prohlašuje, že tento VIVO SX8 je ve shodě se základními požadavky a dalšími příslušnými ustanoveními směrnice 2014/53/EU.
Dansk [Danish]	Undertegnede DEXIBELL erklærer herved, at følgende udstyr VIVO SX8 overholder de væsentlige krav og øvrige relevante krav i direktiv 2014/53/EU.
Eesti [Estonian]	Käesolevaga kinnitab DEXIBELL seadme VIVO SX8 vastavust direktiivi 2014/53/EL põhinõuetele ja nimetatud direktiivist tulenevatele teistele asjakohastele sätetele.
Ελληνική [Greek]	ΜΕ ΤΗΝ ΠΑΡΟΥΣΑ DEXIBELL ΔΗΛΩΝΕΙ ΟΤΙ VIVO SX8 ΣΥΜΜΟΡΦΩΝΕΤΑΙ ΠΡΟΣ ΤΙΣ ΟΥΣΙΩΔΕΙΣ ΑΠΑΙΤΗΣΕΙΣ ΚΑΙ ΤΙΣ ΛΟΙΠΕΣ ΣΧΕΤΙΚΕΣ ΔΙΑΤΑΞΕΙΣ ΤΗΣ ΟΔΗΓΙΑΣ 2014/53/ΕΕ.
Íslenska [Icelandic]	Hér, DEXIBELL, því yfir að þetta VIVO SX8 tæki er í samræmi við grunnkröfur og önnur viðeigandi ákvæði tilskipana 2014/53/ESB
Latviešu valoda [Latvian]	Ar šo DEXIBELL deklarē, ka VIVO SX8 atbilst Direktīvas 2014/53/ES būtiskajām prasībām un citiemar to saistītajiem noteikumiem.
Lietuvių kalba [Lithuanian]	Šiuo DEXIBELL deklaruoja, kad šis VIVO SX8 atitinka esminius reikalavimus ir kitas 2014/53/ES Direktyvos nuostatas.
Malti [Maltese]	Hawnhekk, DEXIBELL, jiddikjara li dan VIVO SX8 jikkonforma mal-htigijiet essenzjali u ma provvedimenti oħrajn relevanti li hemm fid-Dirrettiva 2014/53/UE.
Magyar [Hungarian]	Alulírott, DEXIBELL nyilatkozom, hogy a VIVO SX8 megfelel a vonatkozó alapvető követelményeknek és az 2014/53/EU irányelv egyéb előírásainak.
Norsk [Norwegian]	Herved DEXIBELL, erklærer at denne VIVO SX8 enheten, er i samsvar med de grunnleggende kravene og andre relevante bestemmelser i direktivene 2014/53/EU
Polski [Polish]	Niniejszym DEXIBELL oświadcza, że VIVO SX8 jest zgodny z zasadniczymi wymogami oraz pozostałymi stosownymi postanowieniami Dyrektywy 2014/53/UE.
Română [Romanian]	Prin prezenta, DEXIBELL declară că acest dispozitiv VIVO SX8 este în conformitate cu cerințele esențiale și alte prevederi relevante ale Directivei 2014/53/UE
Slovenščina [Slovenian]	DEXIBELL izjavlja, da je ta VIVO SX8 v skladu z bistvenimi zahtevami in ostalimi relevantnimi določili direktive 2014/53/EU.
Slovenčina [Slovak]	DEXIBELL týmtovyhlasuje, že VIVO SX8 spĺňa základné požiadavky a všetky príslušné ustanovenia Smernice 2014/53/EU.
Suomi [Finnish]	DEXIBELL vakuuttaa täten että VIVO SX8 tyyppinen laite on direktiivin 2014/53/EU oleellisten vaatimusten ja sitä koskevien direktiivin muiden ehtojen mukainen.
Svenska [Swedish]	Härmed intygar DEXIBELL att denna VIVO SX8 står i överensstämmelse med de väsentliga egenskapskrav och övriga relevanta bestämmelser som framgår av direktiv 2014/53/EU.

# DEXIBELL

**DEXIBELL**

is a brand of

PROEL SPA

(Worldwide Headquarters)

Via alla Ruenia, 37/43

64027 Sant'Omero (TE) - ITALY

Tel. +39 0861 81241

Fax +39 0861 887862

P.I. 00778590679

N.Reg.AEE IT 08020000002762

[info@dexibell.com](mailto:info@dexibell.com)

[dexibell.com](http://dexibell.com)

